

JVC



DIGITAL CAMCORDER

GR-DVF1

ENGLISH

Please visit our CyberCam Homepage on the World Wide Web and answer our Consumer Survey (in English only):

<http://www.jvc-victor.co.jp/index-e.html>

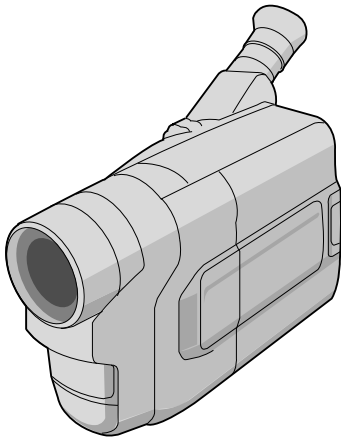

Mini **DV** PAL



INSTRUCTIONS

LYT0242-001A

EN

Dear Customer,

Thank you for purchasing this digital camcorder. Before use, please read the safety information and precautions contained in the following pages to ensure safe use of this product.

Using This Instruction Manual

- All major sections and subsections are listed in the Table Of Contents (☞ pg. 5).
- Notes appear after most subsections. Be sure to read these as well.
- Basic and advanced features/operation are separated for easier reference.

It is recommended that you . . .

- refer to the Index (☞ pgs. 62 – 66) and familiarize yourself with button locations, etc. before use.
- read thoroughly the Safety Precautions. They contain extremely important information regarding the safe use of this product.

You are recommended to carefully read the cautions on pages 67 and 68 before use.

SAFETY PRECAUTIONS

WARNING:

TO PREVENT FIRE OR SHOCK HAZARD, DO NOT EXPOSE THIS UNIT TO RAIN OR MOISTURE.

Warning on lithium cell battery (for clock operation and remote control unit)

The battery used in this device may present a fire or chemical burn hazard if mistreated. Do not recharge, disassemble, heat above 100°C or incinerate.

Replace the battery with Maxell, Panasonic (Matsushita Electric), Sanyo or Sony CR2025; use of another battery may present a risk of fire or explosion.

- Dispose of used battery promptly.
- Keep away from children.
- Do not disassemble and do not dispose of in fire.

CAUTIONS:

- To prevent shock, do not open the cabinet. No user serviceable parts inside. Refer servicing to qualified personnel.
- When you are not using the AC Power Adapter/Charger for a long period of time, it is recommended that you disconnect the power cord from AC outlet.

NOTES:

- *The rating plate (serial number plate) and safety caution are on the bottom and/or the back of the main unit.*
- *The rating plate (serial number plate) of the AC Power Adapter/Charger is on its bottom.*

This camcorder is designed to be used with PAL-type colour television signals. It cannot be used for playback with a television of a different standard. However, live recording and viewfinder playback are possible anywhere. Use the BN-V12U/V20U battery packs and, to recharge them, the provided multi-voltage AC Power Adapter/Charger. (An appropriate conversion adapter may be necessary to accommodate different designs of AC outlets in different countries.)

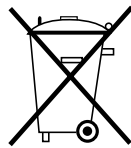
Crossed Out Dust Bin Mark

Cd

- The Crossed Out Dust Bin Mark on the battery pack indicates that the product complies with Directives 91/157/EEC and 93/86/EEC.
- Nickel-Cadmium (Ni-Cd) battery pack must be recycled or disposed of properly.

This unit is produced to comply with Standard IEC Publ. 65.

SAFETY PRECAUTIONS

Do not point the lens or the viewfinder directly into the sun. This can cause eye injuries, as well as lead to the malfunctioning of internal circuitry. There is also a risk of fire or electric shock.

CAUTION! The following notes concern possible physical damage to the camcorder and to the user.

When carrying, be sure to always securely attach and use the provided shoulder strap. Carrying or holding the camcorder by the viewfinder can result in dropping the unit, or in a malfunction.

Take care not to get your finger caught in the cassette cover. Do not let children operate the camcorder, as they are particularly susceptible to this type of injury.

Do not use a tripod on unsteady or unlevel surfaces. It could tip over, causing serious damage to the camcorder.

CAUTION! Connecting cables (Audio/Video, S-Video, Editing, DC) to the camcorder and leaving the unit on top of the TV is not recommended, as tripping on the cables will cause the camcorder to fall, resulting in damage.

About Batteries

DANGER! Do not attempt to take the batteries apart, or expose them to flame or excessive heat, as there is a risk of fire or explosion.

WARNING! Do not allow the battery terminals, or the battery itself, to come in contact with metals, as this can result in a short circuit and possibly start a fire.

PROVIDED ACCESSORIES

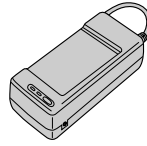

• AC Power Adapter/
Charger AA-V15EG

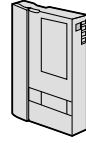

• MiniDV Cassette Tape
30 Min (DVM-30)
M-DV30ME

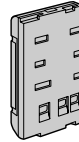

• Battery Pack
BN-V12U

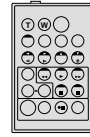

• Remote Control Unit
RM-V712U



• Editing Cable

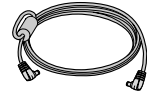

• DC Cord



• S-Video Cable



• Audio/Video
(A/V) cable

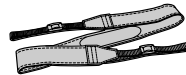

• Shoulder Strap



• Lithium Battery
CR2025 x 2
(for clock
operation
and remote
control unit)



• Cable Adapter

Mini **DV** PAL

■ This camcorder is designed exclusively for the digital video cassette. Only cassettes marked **Mini DV** can be used with this unit.

Before recording an important scene . . .

.... make sure you only use cassettes with the Mini DV mark **Mini DV**.

.... remember that this camcorder is not compatible with other digital video formats.

.... remember that this camcorder is intended for private consumer use only. Any commercial use without proper permission is prohibited. (Even if you record an event such as a show, performance or exhibition for personal enjoyment, it is strongly recommended that you obtain permission beforehand.)

The digital camcorder converts incoming audio and video signals into digital form for recording.

A video signal is composed of a luminance signal (Y) and colour signals (R-Y and B-Y). These signals are identified and recorded digitally (Digital Component Recording). The A/D (Analogue to Digital) converter samples the Y signal at 13.5 MHz, and R-Y and B-Y at 6.75 MHz, and changes them to an 8-bit quantum signal.

Sound sampled at 48 kHz is changed to a 16-bit quantum signal, and sound sampled at 32 kHz is converted to a 12-bit signal.

NOTE:

The data recorded on a tape is digital, but the output of this camcorder is analogue.

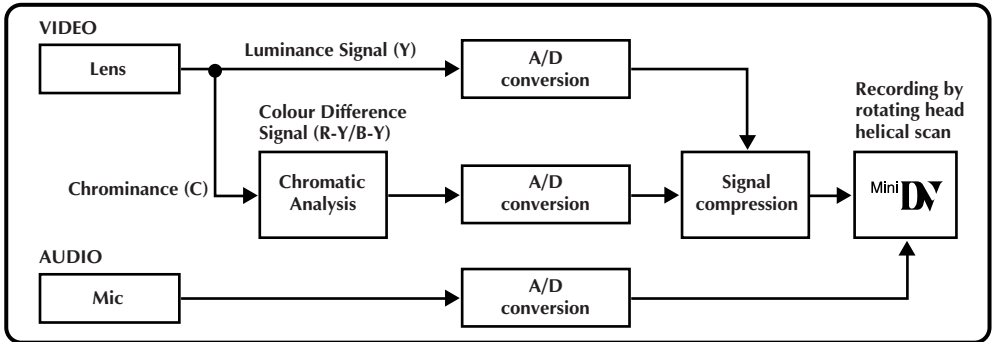

This camcorder separates the data into blocks, writing one block of each data type on each track of the tape.

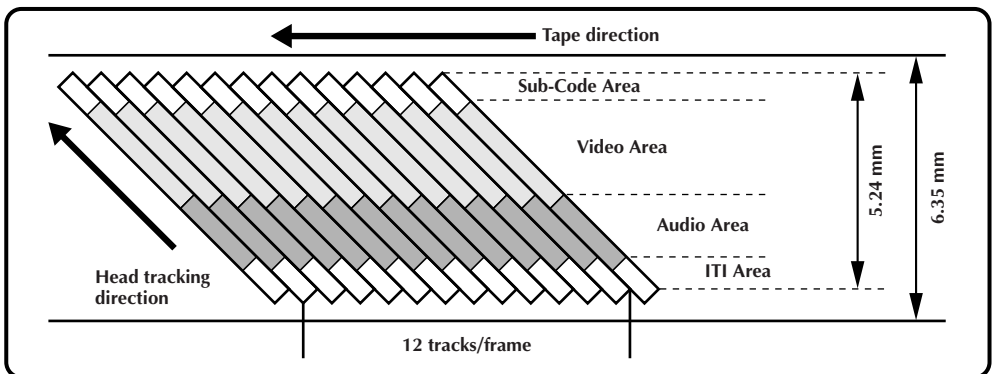

1 Sub-Code Area

The Time Code and Date/Time data are written here, separate from the video data. This enables you to display the date and time during playback, even if they weren't displayed while recording.

2 Video Area

The digital video signal is recorded here.

3 Audio Area

The digital audio signal is recorded here.

4 ITI (Insert and Tracking Information) Area

Insert editing and post-recording editing tracking signals are recorded here.

PROVIDED ACCESSORIES	3
ABOUT DV	4
GETTING STARTED	6 – 13
Power	6
Clock (Lithium) Battery Insertion/Removal	8
Date/Time Settings	9
Loading/Unloading A Cassette	10
Recording Mode Setting	11
Grip Adjustment	12
Viewfinder Adjustment	12
Shoulder Strap Attachment	13
Tripod Mounting	13
RECORDING	14 – 35
Basic Recording	14
Advanced Features	19
PLAYBACK	36 – 41
Basic Playback	36
Advanced Features	38
Connections	40
TAPE DUBBING	42
USING THE REMOTE CONTROL UNIT	43 – 55
Random Assemble Editing	48
For More Accurate Editing	52
Audio Dubbing	54
TROUBLESHOOTING	56 – 60
USER MAINTENANCE	61
INDEX	62 – 66
Controls, Connectors And Indicators	62
Indications	64
Terms	66
CAUTIONS	67 – 68
SPECIFICATIONS	69

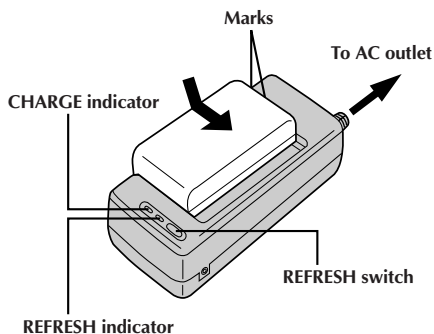

REFRESH

The AC Power Adapter/Charger features a REFRESH function that allows you to fully discharge the battery pack before recharging.

Perform the REFRESH function after no less than 5 chargings.

To discharge the battery . . .

.... attach the battery pack to the adapter as shown in the above illustration. Then push REFRESH. The REFRESH indicator lights when discharging starts, and goes out when discharging is complete.

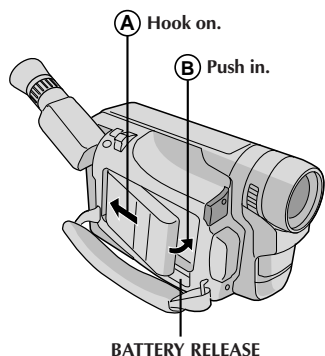

ATTENTION:

Before detaching the power source, make sure that the camcorder's power is turned off. Failure to do so can result in a camcorder malfunction.

Power

This camcorder's 3-way power supply system lets you choose the most appropriate source of power.

NOTES:

- No function is available without power supply.
- Use only specified power supply.
- Do not use provided power supply units with other equipment.

CHARGING THE BATTERY PACK

1 SUPPLY POWER

Connect the charger's AC power cord to a wall outlet.

2 ATTACH BATTERY PACK

Align the marks and slide the battery pack in the direction of the arrow until it locks in place.

- The CHARGE indicator begins blinking to indicate charging has started.

3 DETACH BATTERY PACK

When the CHARGE indicator stops blinking but stays lit, charging is finished. Slide the battery pack opposite the direction of the arrow.

Battery pack	Charging time	Discharging time
BN-V12U	approx. 1 hr. 10 min.	approx. 3 hrs. 30 min.
BN-V20U	approx. 1 hr. 50 min.	approx. 6 hrs. 40 min.

USING THE BATTERY PACK

1 ATTACH BATTERY PACK

Hook its end to the camcorder (A) and push the battery pack in until it locks in place (B).

2 DETACH BATTERY PACK

Slide BATTERY RELEASE and pull out the battery pack.

Battery pack	Approximate recording time (unit: min.)
BN-V12U	75 (40)
BN-V20U	120 (70)

(): when the video light is on.

INFORMATION:

VU-V856KIT is a set composed of the BN-V856U battery pack and AA-V80EG AC Power Adapter/Charger. The BN-V856U battery pack provides approx. 7 hours of recording time when the video light is off. Also read thoroughly the VU-V856KIT's instruction manuals. It is impossible to charge the BN-V856U battery pack using the provided AC Power Adapter/Charger. Use the optional AA-V80EG AC Power Adapter/Charger.

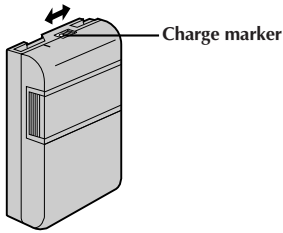

Charge Marker

A charge marker is provided on the battery pack to help you remember whether it has been charged or not. Two colours are provided (red and black)—you choose which one means charged and which means discharged.

NOTES:

- The recording time per charge is affected by such factors as the time spent in Record-Standby mode and the frequency of zooming. It is safer to have spare battery packs.
- Charging times noted on page 6 are for fully discharged battery pack, and discharging times are for fully charged battery pack.
- Charging and discharging times vary according to the ambient temperature and the status of the battery pack.
- Remember to set the charge marker after charging a battery pack or after detaching a discharged one from your camcorder.
- Perform the REFRESH function after no less than 5 chargings.
- While the AC Power Adapter/Charger's power cord is disconnected from the AC outlet, it is possible to discharge the battery by pressing the REFRESH switch. During that time, the AC Power Adapter/Charger does not charge the battery. When discharging is complete, detach the battery from the AC Power Adapter/Charger to store it.
- High temperatures can damage the battery pack, so use only where good ventilation is available. Do not allow it to discharge in container, such as a bag.
- If you stop recharging or discharging part way through, make sure to remove the battery pack before unplugging the adapter's AC cord.
- Remove the battery pack from the adapter immediately after discharging.
- To avoid interference with reception, do not use the AC Power Adapter/Charger near a radio.
- Make sure you unplug the DC cord before charging or discharging the battery pack.
- The CHARGE indicator may not light properly with a brand new battery pack, or with one that has been stored for an extended period. In this case, remove and reattach the battery pack and recharge it. The CHARGE indicator should blink during recharging. If not, contact your nearest JVC dealer.

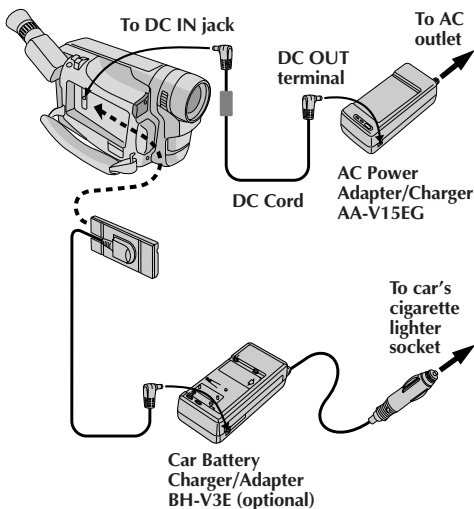

USING AC POWER

Use the AC Power Adapter/Charger (connect as shown in the illustration on left).

NOTES:

- The provided AC Power Adapter/Charger features automatic voltage selection in the AC range from 110 V to 240 V.
- When using the DC cord, make sure you connect the end of the cord with the core filter to the camcorder. The core filter reduces interference.

USING A CAR BATTERY

Use the optional Car Battery Charger/Adapter (connect as shown in the illustration on left).

NOTES:

- When using the car battery, leave the engine idling.
- The optional Car Battery Charger/Adapter (BH-V3E) can also be used to charge the battery pack (other than BN-V20U/V856U).
- When using the optional Car Battery Charger/Adapter, refer to the respective instruction booklet.

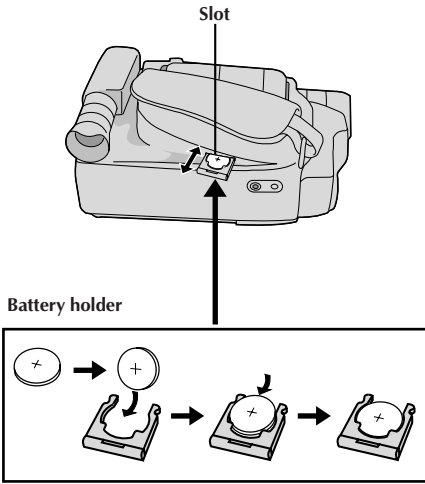

Clock (Lithium) Battery Insertion/Removal

This battery is necessary for clock operation and to perform date/time settings.

- 1 SWITCH OFF POWER**
Switch off the unit's power.
- 2 REMOVE BATTERY HOLDER**
Pull out the battery holder.
- 3 INSERT BATTERY IN HOLDER**
Insert the battery in the holder, and be sure to have the "+" mark visible.
- 4 RE-INSERT HOLDER**
Slide the holder back into the slot until you hear a click.

NOTES:

- See "SAFETY PRECAUTIONS" (☞ pg. 2) for information on safe handling of lithium batteries.
- To avoid losing the battery and/or battery holder, place the camcorder with the grip side up as shown in the illustration when inserting/removing the battery.

Date/Time Settings

Date and time will automatically be recorded on tape at all times. It is your choice to display it or not during playback (☞ pg. 39).

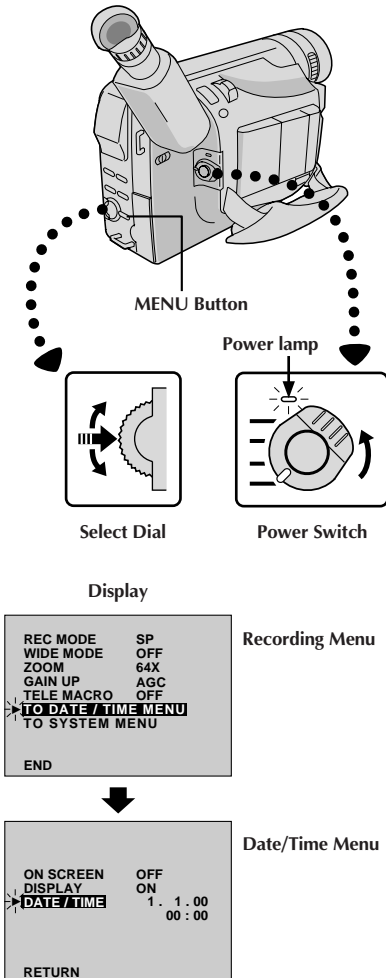

1 SELECT OPERATION MODE

Set the Power Switch to "PRO.".

- The power lamp comes on and the camcorder is turned on.

2 ACCESS RECORDING MENU

Press MENU. The Recording Menu appears.

3 ACCESS DATE/TIME MENU

Move the highlight bar to "TO DATE/TIME MENU" by rotating the Select Dial. Press the Select Dial and the Date/Time Menu appears.

4 INPUT DATE AND TIME

Move the highlight bar to "DATE/TIME" by rotating the Select Dial. Press the Select Dial and "day" is highlighted and begins blinking. Rotating the Select Dial, input the day. Press the Select Dial. Repeat the procedure to input the month, year, hour and minute.

- Press the Select Dial twice when the highlight bar is set to "RETURN" to exit.

NOTE:

Even if you select "DATE/TIME", if the parameter is not highlighted the camcorder's internal clock continues to operate. Once you move the highlight bar to the first date/time parameter (day), the clock stops. When you finish setting the minute and press the Select Dial, the date and time begin operation from the date and time you just set.

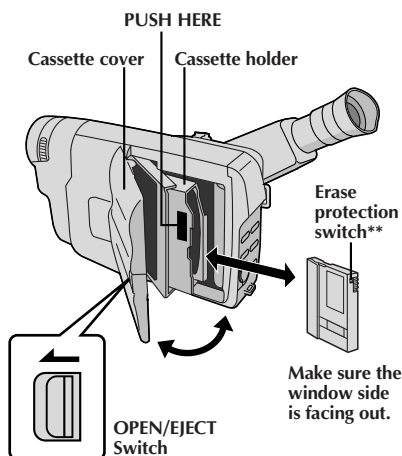

** To protect valuable recordings . . .

.... slide the erase protection switch on the back of the tape in the direction of "SAVE". This prevents this tape from being recorded over. If you decide later that you do want to record on this tape, slide the switch back to "REC" before loading the tape.

Loading/Unloading A Cassette

The camcorder needs to be powered up to load or eject a cassette.

1 OPEN CASSETTE COVER

Press **OPEN/EJECT** in the direction of the arrow then swing the cover open until it locks. The holder opens automatically.

- Do not touch internal components.

2 INSERT/REMOVE TAPE

Insert or remove a tape and press "PUSH HERE" to close the cassette holder.

- Once the cassette holder is closed, it recedes automatically. Wait until it recedes completely before closing the cassette cover.
- When the battery's charge is low, you may not be able to close the cover. Do not apply force. Replace the battery with a fully charged one before continuing.

3 CLOSE CASSETTE COVER

Approximate recording time

Tape	Recording mode	
	SP	LP
DVM-30	30 min.	45 min.
DVM-60	60 min.	90 min.

NOTES:

- It takes a few seconds for the cassette holder to open. Do not apply force.
- If you wait a few seconds and the cassette holder does not open, close the cassette cover and try again. If the cassette holder still does not open, turn the camcorder off then on again.
- When the camcorder is suddenly moved from a cold place to a warm environment, wait a short time before opening the cover.
- Closing the cassette cover before the cassette holder comes out may cause damage to the camcorder.
- Even when the camcorder is switched off, a cassette can be loaded or unloaded. After the cassette holder is closed with the camcorder switched off, however, it may not recede. It is recommended to turn the power on before loading or unloading.
- When resuming recording, once you open the cassette cover a blank portion will be recorded on the tape or a previously recorded scene will be erased (recorded over) regardless of whether the cassette holder came out or not. See page 18 for information about recording from the middle of a tape.

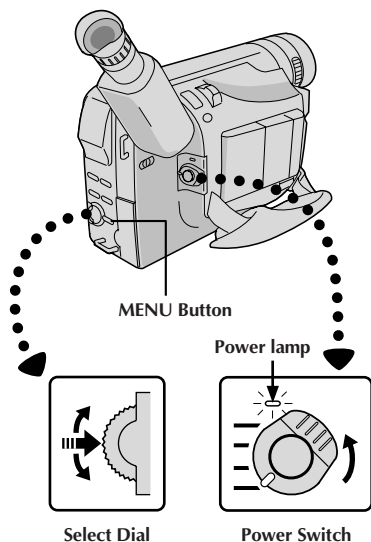

Display

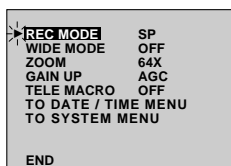

Recording Menu

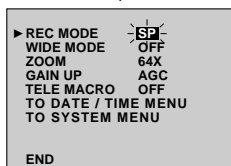

Recording mode indicator

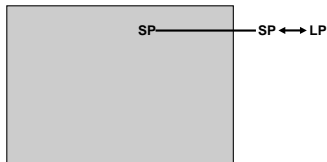

Recording Mode Setting

Set depending on your preference.

1 SELECT OPERATION MODE

Set the Power Switch to "PRO.".

- The power lamp comes on and the camcorder is turned on.

2 ACCESS RECORDING MENU

Press MENU. The Recording Menu appears.

3 SET RECORDING MODE

First move the highlight bar to "REC MODE" by rotating the Select Dial. Press the Select Dial and the parameter "SP" or "LP" is highlighted. Select "SP" or "LP" by rotating the Select Dial. Press the Select Dial twice to exit from the Recording Menu.

- "LP" (Long Play) is more economical, providing 1.5 times the recording time.
- Audio Dubbing is impossible on a tape recorded in the LP mode.

NOTES:

- If the recording mode is switched during recording, the playback picture will be blurred at the switching point.
- It is recommended that tapes recorded in the LP mode on this camcorder be played back on this camcorder.
- During playback of a tape recorded on another camcorder, blocks of noise may appear or there may be momentary pauses in the sound.

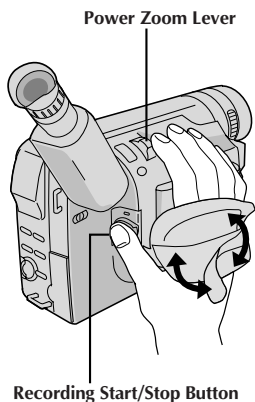

Grip Adjustment

- 1 EXPAND LOOP**
Separate the Velcro strip.
- 2 INSERT HAND**
Pass your right hand through the loop and grasp the grip.
- 3 ADJUST STRAP LENGTH**
Adjust so that your thumb and fingers can easily operate the Recording Start/Stop Button and Power Zoom Lever. Refasten the Velcro strip.

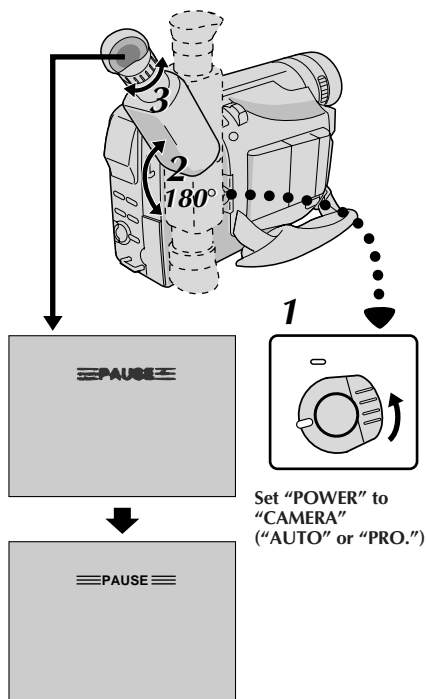

Viewfinder Adjustment

- 1 SELECT OPERATION MODE**
Set the Power Switch to "CAMERA" ("AUTO" or "PRO.").
- 2 POSITION VIEWFINDER**
Adjust the viewfinder manually for best viewability (see illustration on left).
- 3 ADJUST DIOPTRE**
Turn the Dioptre Adjustment Control until the indications in the viewfinder are clearly focused.

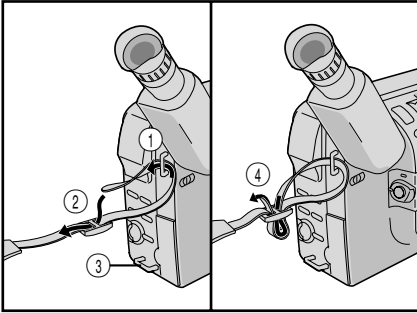

Shoulder Strap Attachment

1 ATTACH STRAP

Following the illustration on left, thread the strap through the top of the eyelet (1), then fold it back and thread it through the buckle (2). Repeat the procedure to attach the other end of the strap to the other eyelet (3), making sure the strap is not twisted.

2 ADJUST LENGTH

Adjust as shown in the illustration on left (4).

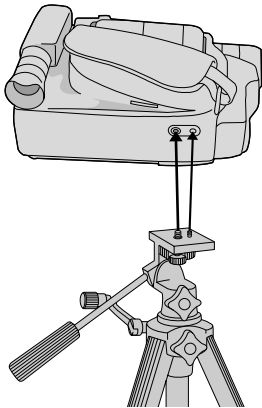

Tripod Mounting

1 ALIGN AND TIGHTEN

Align the screw and camera direction stud on the tripod with the camera's mounting socket and stud hole. Then tighten the screw.

CAUTION:

When using a tripod, be sure to open and extend its legs fully to stabilize the camcorder. To prevent damage to the unit caused by falling over, do not use a small-sized tripod.

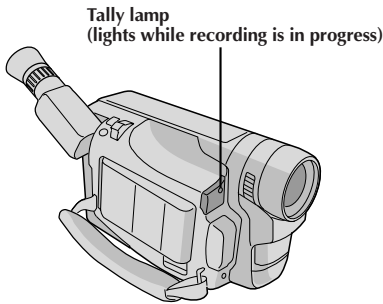
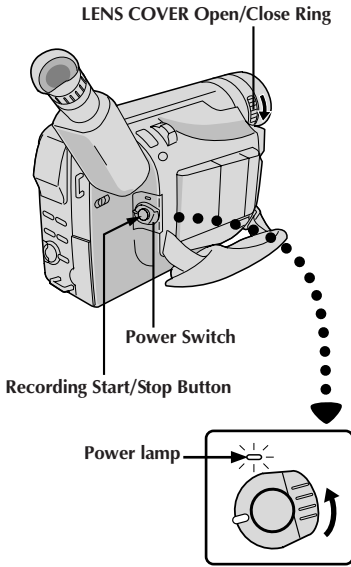
**NOTE:**

You should already have performed the procedures listed below. If not, do so before continuing.

- Power (☞ pg. 6)
- Recording Mode Setting (☞ pg. 11)
- Grip Adjustment (☞ pg. 12)
- Viewfinder Adjustment (☞ pg. 12)

1 LOAD A CASSETTE

Press **OPEN/EJECT** in the direction of the arrow printed on it, then swing the cassette cover open until it locks. The holder opens automatically. Insert a tape and press "PUSH HERE" to close the cassette holder.

- Once the cassette holder is closed, it recedes automatically. Wait until it recedes completely before closing the cassette cover.

2 ENTER RECORD-STANDBY MODE

Turn the **LENS COVER Open/Close Ring** to open the lens cover, then set the Power Switch to "CAMERA" ("AUTO" or "PRO.").

- The power lamp lights and the camcorder enters the Record-Standby mode.
- The scene you are aimed at appears on the viewfinder screen, with the word "PAUSE" superimposed upon it.

3 START SHOOTING

Press the Recording Start/Stop Button.

- "REC" appears in the viewfinder while recording is in progress.

Power Switch Position

According to the Power Switch position you have selected, the following functions are available:

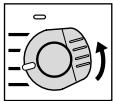

AUTO
(Full Auto mode):

Allows you to record using NO special effects or manual adjustments. Suitable for standard recording. When set to this mode, "F.AUTO" appears.

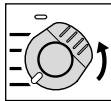

PRO.
(PRO. mode):

Allows you to set various recording functions using the menus. If you want more creative capabilities than full auto recording, try this mode. When set to this mode, "PRO." appears.

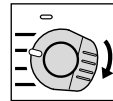

POWER OFF:

Allows you to switch off the camcorder. After setting to this position, Manual Focus and Exposure Control are automatically reset to "AUTO".

Tape remaining time indicator

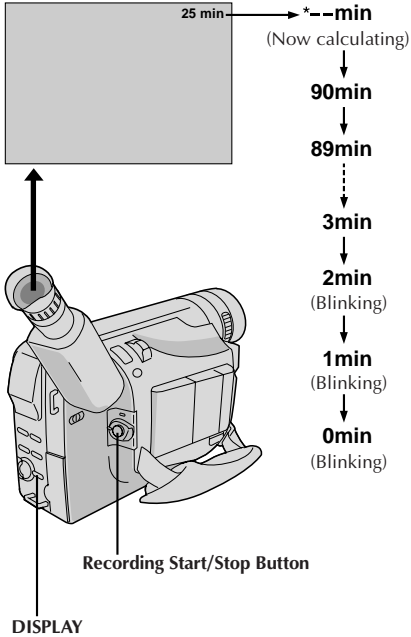
**4 STOP RECORDING**

Press the Recording Start/Stop Button again to stop recording.

- The camcorder re-enters the Record-Standby mode.

NOTES:

- The cassette holder cannot be opened unless a power supply is attached.
- There may be a delay after you open the cassette cover until the holder opens. Do not use force.
- The tape remaining time is only displayed in the viewfinder as shown.
- The remaining time indicated in the viewfinder is approximate.
- The time required to calculate the remaining tape length, and the accuracy of the calculation, may vary according to the type of tape used.
- "TAPE END" appears when the tape reaches its end, and the power goes off automatically if left in this condition for 5 minutes. "TAPE END" also appears when a cassette whose tape is already at its end is loaded.
- If the Record-Standby mode continues for 5 minutes, the camcorder's power shuts off automatically. Set the Power Switch to "POWER OFF", and then back to "CAMERA" to turn the camcorder on again.
- When a blank portion is left between recorded scenes on the tape, the time code is interrupted and errors may occur when editing the tape. Continue recording from where you stop so that there are no gaps by following "Recording from the middle of a tape" (pg. 18).
- The LENS COVER warning blinks for about 5 seconds when the camcorder is turned on with the cover closed.

Viewfinder Indications

You can make the Viewfinder indications appear/disappear.

1 PRESS DISPLAY BUTTON

When you do not want the indications to appear, press **DISPLAY** for longer than approximately 1 second. Certain indications disappear. Press again for longer than approx. 1 second to make the indications reappear.

NOTE:

It is impossible to make the tape running indicator "▶▶▶" and warnings etc. disappear from the viewfinder. For the indications that can be removed, pg. 64 and 65.

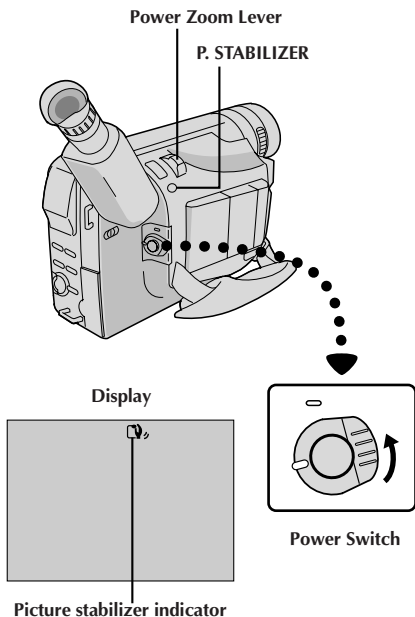
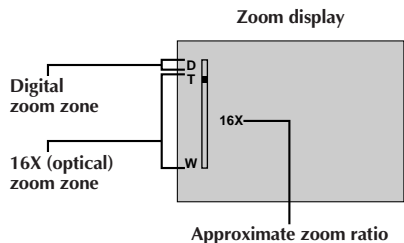
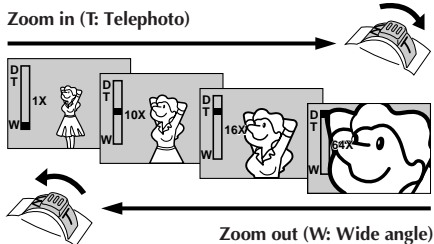

FEATURE: Zooming

PURPOSE:

To produce the zoom in/out effect, or an instantaneous change in image magnification.

OPERATION:

Zoom In

Push the Power Zoom Lever towards "T".

Zoom Out

Push the Power Zoom Lever towards "W".

- The quicker you push the Power Zoom Lever, the quicker the zoom action.

NOTES:

- Focusing may become unstable during Zooming. In this case, set the zoom while in Record-Standby, lock the focus by using the manual focus (☞ pg. 31), then zoom in or out in Record mode.
- In Full Auto mode (when the Power Switch is set to "AUTO"), zoom magnification of up to 64X is possible. In Pro. mode (when the Power Switch is set to "PRO."), zooming is possible to a maximum of 160X or can be switched to 16X magnification offered by optical zoom.
- Zoom magnification of over 16X is done through Digital image processing, and is therefore called Digital Zoom.
- During Digital zoom, the quality of image may suffer.
- Digital zoom cannot be used while functions done through Digital image processing (Picture Wipe/Dissolve function, ☞ pg. 26, Snapshot, ☞ pg. 20, etc.) are activated.
- Macro shooting (as close as approx. 1.5 cm to the subject) is possible when the Power Zoom Lever is set all the way to "W".

FEATURE: Picture Stabilizer

PURPOSE:

To compensate for unstable images caused by camera-shake, particularly at high magnification.

OPERATION:

- 1) Press P. STABILIZER. "☞" appears.
 - To switch off the Picture Stabilizer, press P. STABILIZER. The indicator disappears.

NOTES:

- Accurate stabilization may not be possible if hand shake is excessive, or under the following conditions:
 - When shooting subjects with vertical or horizontal stripes.
 - When shooting dark or dim subjects.
 - When shooting subjects with excessive backlighting.
 - When shooting scenes with movement in various directions.
 - When shooting scenes with low-contrast backgrounds.
- Switch off the Picture Stabilizer when recording with the camcorder on a tripod.
- The "☞" indicator appears blinking if the Stabilizer cannot be used.

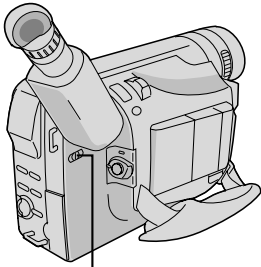

LIGHT OFF/AUTO/ON

DANGER

- The video light can become extremely hot. Do not touch it either while in operation or soon after turning it off, otherwise serious injury may result.
- Do not place the camcorder into the carrying case immediately after using the video light, since it remains extremely hot for some time.
- When operating, keep a distance of about 30 cm. between the video light and people or objects.
- Do not use near flammable or explosive materials.
- It is recommended that you consult your nearest JVC dealer for replacing the video light.

FEATURE: Video Light

PURPOSE:

To brighten the scene when natural lighting is too dim.

OPERATION:

1) Set the **LIGHT OFF/AUTO/ON** Switch as required:

OFF : Turns off the light.

AUTO : Automatically turns on the light when the camcorder senses insufficient lighting on the subject.

ON : Always keeps the light on as long as the camcorder is turned on.

- The video light can only be used with the camcorder's power on.
- It is recommended to set the white balance (☞ pg. 34) to  when you use the video light.
- When not using the video light, turn it off to save battery power.

NOTES:

- Even if the battery indicator () does not blink if the battery pack's charge is low, the camcorder may turn off automatically when you turn on the video light, or when you start recording with the video light turned on.
- When the **LIGHT OFF/AUTO/ON** Switch is set to "AUTO":
 - Depending on the lighting conditions, the video light may keep turning on and off. In this case, manually switch the light on or off using the **LIGHT OFF/AUTO/ON** switch.
 - While the "SHUTTER" mode (☞ pg. 29) is engaged, the light is likely to stay on.
 - While the "TWILIGHT" mode (☞ pg. 29) is engaged, the light will not activate.

NOTE: Recording From The Middle Of A Tape

Time Code

During recording, a time code is recorded on the tape. This code is to confirm the location of the recorded scene on the tape during playback.

If recording starts from a blank portion, the time code begins counting from "00:00:00" (minute:second:frame). If recording starts from the end of a previously recorded scene, the time code continues from the last time code number.

To perform Random Assemble Editing (☞ pg. 48 – 53), time code is necessary. If during recording a blank portion is recorded partway through the tape, the time code is interrupted. When recording is resumed, the time code starts counting up again from "00:00:00". This means the camcorder may record the same time codes as those existing in a previously recorded scene. To prevent leaving a blank portion on a tape, perform the procedure in "Recording From The Middle Of A Tape" (see below) in the following cases;

- After playing back the recorded tape, when you shoot again.
- When power shuts off during shooting.
- When a tape is removed and re-inserted during shooting.
- When shooting using a partially recorded tape.
- When shooting on a blank portion located partway through the tape.
- When shooting again after already shooting a scene and opening/closing the cassette cover.

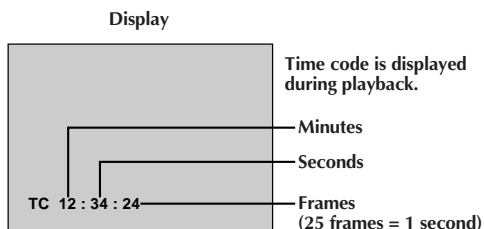

Recording From The Middle Of A Tape

1. Play back a tape to find the spot at which you want to start recording, then engage the Still Playback mode (☞ pg. 37).
2. Set the Power Switch to "CAMERA" ("AUTO" or "PRO.") and start recording.

NOTES:

- The Time Code cannot be reset.
- During fast-forwarding and rewinding, time code indication does not move smoothly.

When blank portion is recorded on a tape

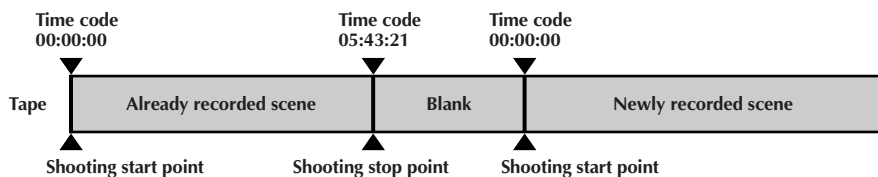

Proper recording

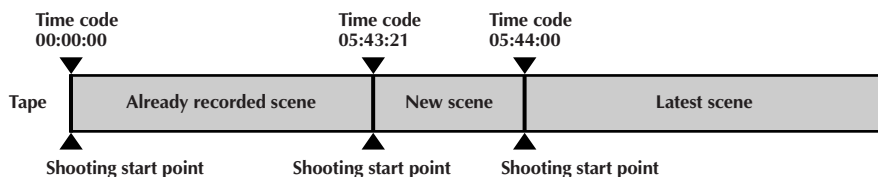

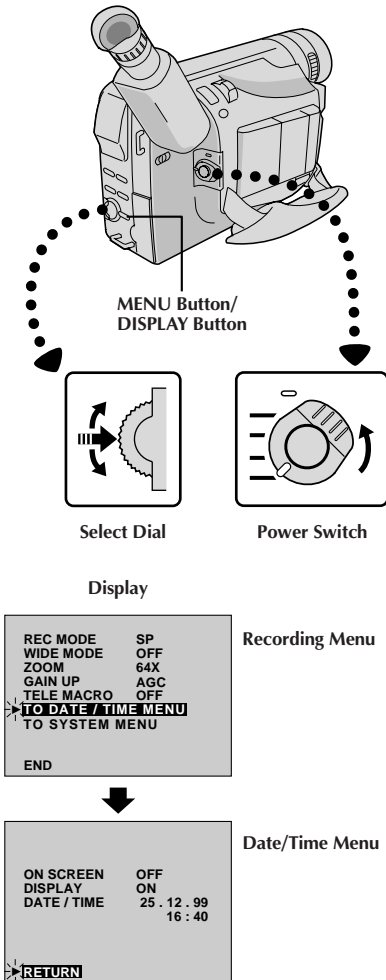

Displaying The Date And Time During Recording

When the Power Switch is set to "PRO.", you can choose whether to display the date and time during recording or not. You must first set the date and time ("Date/Time Settings", pg. 9). Set "DISPLAY" to "ON" in the Date/Time Menu. The Date/Time is always displayed when the Power Switch is set to "AUTO".

- 1 SELECT OPERATION MODE**
Set the Power Switch to "PRO.".
- 2 ACCESS RECORDING MENU**
Press MENU. The Recording Menu appears.
- 3 ACCESS DATE/TIME MENU**
Move the highlight bar to "TO DATE/TIME MENU" by rotating the Select Dial. Press it and the Date/Time Menu appears.
- 4 SELECT FUNCTION**
Move the highlight bar to "DISPLAY" by rotating the Select Dial, then press it.
- 5 SET FUNCTION PARAMETERS**
Cycle through the available settings of the selected functions by rotating the Select Dial and stop when the one you want is displayed. Then press it and the highlight bar automatically moves to "RETURN".
- 6 CLOSE RECORDING MENU**
Press the Select Dial twice. Selection is complete and the menu disappears.

NOTES:

- Connect the camcorder to a TV and set "ON SCREEN" to "ON" in the Date/Time Menu. The display appears on the connected TV.
- The Indicator/Display function overrides these settings. Even if you have set "ON SCREEN" to "ON", pressing **DISPLAY** for longer than 1 second removes the indications from the screen. Pressing it for longer than 1 second again makes the indications re-appear ("Viewfinder Indications", pg. 15).

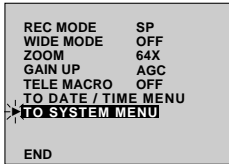
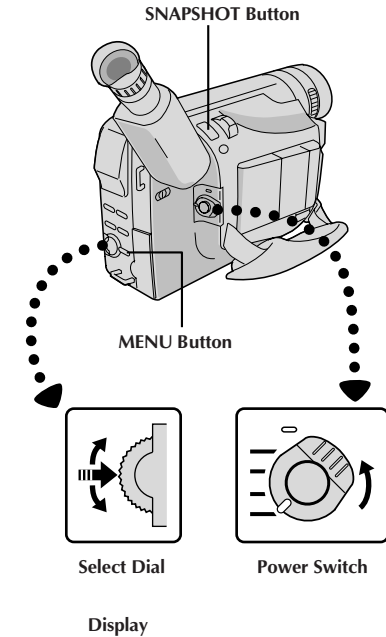

Recording Menu

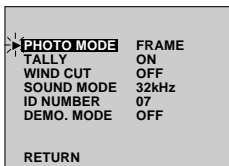

System Menu



During snapshot

Snapshot

Use your camcorder like a regular camera and take a snapshot, or several of them in succession.

SNAPSHOT MODE SELECTION

- 1 SELECT OPERATION MODE**
Set the Power Switch to "PRO."
- 2 ACCESS RECORDING MENU**
Press MENU. The Recording Menu appears.
- 3 ACCESS SYSTEM MENU**
Move the highlight bar to "TO SYSTEM MENU" by rotating the Select Dial. Press it and the System Menu appears.
- 4 SELECT SNAPSHOT MODE**
Move the highlight bar to "PHOTO MODE" by rotating the Select Dial. Press it and choose the appropriate mode among the five Snapshot modes (pg. 21) by rotating it. Stop when the one you want is displayed and press it again. The highlight bar automatically moves to "RETURN". Press the Select Dial twice. Selection is complete and the menu disappears.

SNAPSHOT RECORDING

- 1 TAKE SNAPSHOT**
Press SNAPSHOT.

- Regardless of the Power Switch position ("AUTO" or "PRO."), Snapshot recording takes place using the selected Snapshot mode.

If you press during Record-Standby . . .

.... "PHOTO" appears and a still image will be recorded for approx. 6 seconds, then the camcorder re-enters the Record-Standby mode.

If you press during Recording . . .

.... "PHOTO" appears and a still image will be recorded for approx. 6 seconds, then the normal recording resumes.



FULL*
(Snapshot mode
with no frame)



FRAME*
(Snapshot mode
with frame)



PIN-UP
(Pin-Up mode)

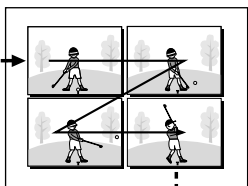

MULTI 4
(Multi-Analyzer 4)

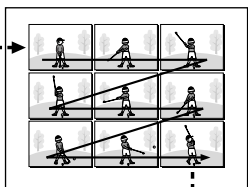

MULTI 9
(Multi Analyzer 9)

Motor Drive Mode

Keeping **SNAPSHOT** pressed provides an effect similar to serial photography. (The interval between the still pictures: approx. 0.7 seconds.)

NOTES:

- In Full Auto mode, all Snapshot modes are available. However, the Snapshot mode cannot be changed.
- During playback as well, all Snapshot modes are available. The shutter sound is not heard.
- However, during playback, "MULTI 4" and "MULTI 9" are not available when the "MONOTONE" or "SEPIA" playback effect (☞ pg. 47) is selected.
- The Snapshot mode (except FULL mode) is not possible while Digital Zoom (zoom magnification of over 16X, ☞ pg. 23) is activated.
- If certain modes of Programme AE with special effects (☞ pg. 28) are activated, some Snapshot modes cannot be used. If you select a Snapshot mode that is unusable in the current situation, the "PHOTO" indication blinks when you press **SNAPSHOT**.

* : There is a momentary camera shutter-type blackout together with the sound effect of a shutter closing, which is recorded together with the image.

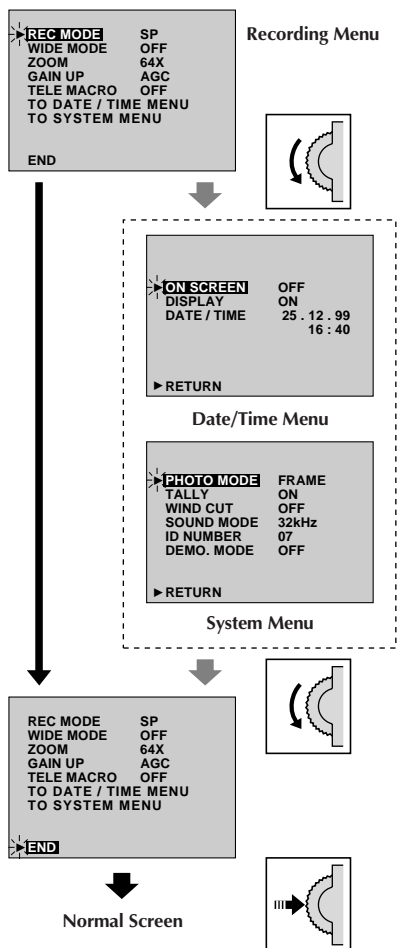
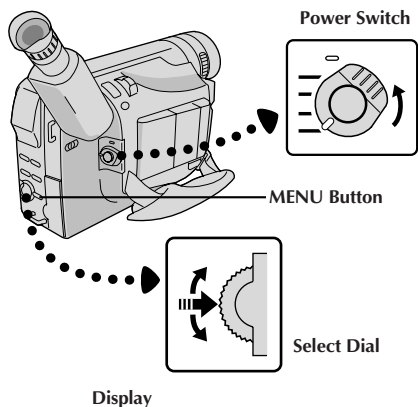

Using Menu For Detailed Adjustment

This camcorder is equipped with an easy-to-use, on-screen menu system that simplifies many of the more detailed camcorder settings.

- 1 ACCESS RECORDING MENU**
Set the Power Switch to "PRO.", then press MENU. The Recording Menu appears.
- 2 SELECT FUNCTION**
Rotate the Select Dial to move the highlight bar to the desired function.

 - If the setting you want cannot be found in the Menu Screen, place the highlight bar on "END", then go to step 6.
- 3 MAKE SETTING**
Press the Select Dial. The setting procedure depends on the function you select.

If you select "REC MODE", "WIDE MODE", "ZOOM", "GAIN UP" or "TELE MACRO" . . .
.... each function's parameter starts blinking. Rotate the Select Dial until the desired parameter appears. Go to step 5.



If you select "TO DATE/TIME MENU" . . .
.... the Date/Time Menu appears. Go to step 4.

If you select "TO SYSTEM MENU" . . .
.... the System Menu appears. Go to step 4.
- 4 SELECT FUNCTION PARAMETERS IN DATE/TIME MENU OR SYSTEM MENU**
Rotate the Select Dial to move the highlight bar to the desired function, then press it.

If you select "DATE/TIME" . . . pg. 9

If you select other functions . . .
.... rotate the Select Dial until the desired parameter appears, then press it. The highlight bar automatically moves to "RETURN". Go to step 5.
- 5 END SETTING**
Press the Select Dial. The Recording Menu reappears and the highlight bar is on "END".
- 6 CLOSE MENU SCREEN**
Press the Select Dial. The normal screen reappears.

Recording Menu Explanations

REC MODE		Allows you to set the recording mode (SP or LP) depending on your preference (☞ pg. 11).
WIDE MODE	OFF	Select "OFF" when you want to use neither "SQUEEZE" nor "CINEMA".
	SQUEEZE	For playback on TVs with an aspect ratio of 16:9. Naturally expands the image to fit the screen without distortion.  appears. When using this mode, refer to your wide-screen TV's instruction manual. During playback/recording on 4:3 TVs/viewfinder, the image is elongated vertically.
	CINEMA	Inserts black bands at the top and bottom of the screen. During playback on wide-screen TVs, the black bands at the top and bottom of the screen are cut and the screen ratio becomes 16:9. When using this mode, refer to your wide-screen TV's instruction manual. During playback/recording on 4:3 TVs/viewfinder, black bands are inserted at the top and bottom of the screen and the image appears like a letterboxed 16:9 movie.
ZOOM	16X	When set to "16X" while using digital zoom, the zoom magnification will reset to 16X since digital zoom will be disengaged.
	64X	Allows you to use the Digital Zoom. By digitally processing and magnifying images, zooming is possible from 16 times (the optical zoom limit), to a maximum of 64 times digital magnification.
	160X	Allows you to use the Digital Zoom. By digitally processing and magnifying images, zooming is possible from 16 times (the optical zoom limit), to a maximum of 160 times digital magnification.
GAIN UP	AGC	This is automatically activated during Full Auto mode. The overall appearance is jagged, but the image is bright.
	AUTO 	The shutter speed is automatically adjusted (1/25 — 1/200 sec.). Shooting a subject in low or poor lighting at 1/25 sec. shutter speed provides a brighter image than in the AGC mode, but the subject's movements are not smooth or natural. When set to this mode, "  " is displayed.
	OFF	Allows you to shoot dark scenes with no picture brightness adjustment.
TELE MACRO	OFF	Usually the distance to a subject where the lens is in focus depends on the zoom magnification. Unless there is a distance more than 1m to the subject, the lens is out of focus at the maximum telephoto setting. When set to "ON", you can shoot a subject as large as possible at a distance of approx. 60 cm. • Depending on the zoom position, the lens may go out of focus.
	ON	
TO DATE/TIME MENU		Refer to "Date/Time Menu Explanations" (☞ pg. 24).
TO SYSTEM MENU		Refer to "System Menu Explanations" (☞ pg. 24).

 : Factory-preset

Date/Time Menu Explanations

ON SCREEN	OFF	Keeps the camcorder's display from appearing on the connected TV screen.
	ON	Makes the camcorder's display appear on screen when the camcorder is connected to a TV.
DISPLAY	ON	Makes the date/time settings appear in the camcorder (☞ pg. 19).
	OFF	Keeps the date/time settings from appearing in the camcorder.
DATE/TIME	Allows you to set the current date and time (☞ pg. 9).	

System Menu Explanations

PHOTO MODE	Allows you to set the parameters for "FULL", "FRAME", "PIN-UP", "MULTI 4" and "MULTI 9" recording (☞ pg. 20).	
TALLY	ON	The tally lamp comes on to signal the start of recording.
	OFF	The tally lamp remains off at all times.
WIND CUT	OFF	Disengages the function which cuts down on noise created by wind.
	ON	Helps cut down on noise created by wind. <ul style="list-style-type: none"> • "🌀" appears. • The quality of the sound will change. This is normal.
SOUND MODE	32 kHz	Enables recording of stereo sound on four separate channels, and is recommended for use when performing audio dubbing.
	48 kHz	Enables recording of stereo sound on two separate channels.
ID NUMBER	This number is necessary when connecting the camcorder to a device such as a computer using the J terminal (JLIP). The numbers range from 01 to 99. Factory setting is 07.	
DEMO. MODE	OFF	Automatic demonstration will not take place.
	ON	Demonstrates certain functions such as Programme AE with special effects, etc., and can be used to confirm how these functions operate. When "DEMO. MODE" is set to "ON" and the Recording Menu is closed, demonstration starts. <p>NOTES:</p> <ul style="list-style-type: none"> • If a tape is in the camcorder, the demonstration cannot be turned on. • By turning off the camcorder, "DEMO. MODE" is set to "OFF" automatically.

 : Factory-preset

Fade/Wipe Effects

These effects let you make pro-style scene transitions. Use these to spice up the transition from one scene to the next. You can also vary transitions from scene to scene.

EFFECT SELECTION

- 1 ACCESS MANUAL MODE ITEM MENU**
Set the Power Switch to "PRO.", then press the Select Dial.
- 2 ACCESS FADER/WIPE MENU**
Rotate the Select Dial to move the highlight bar to "FADER/WIPE", then press it.
- 3 SELECT EFFECT**
Rotate the Select Dial to move the highlight bar to the desired function, then press it.
 - The Fade/Wipe Menu disappears and the effect is reserved. The indicator representing the selected effect appears.

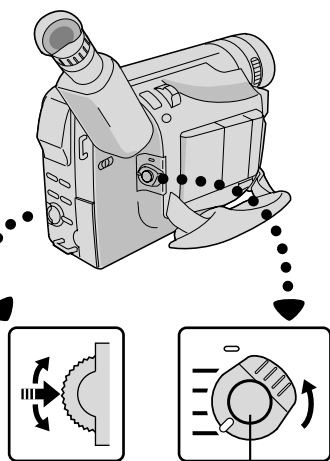

Select Dial

Recording Start/
Stop Button

Display

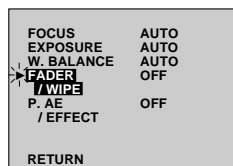
Manual Mode Item
Menu

Fader/Wipe Menu

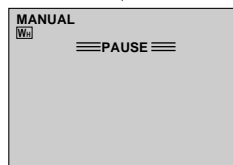
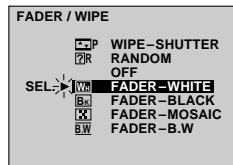

FADE/WIPE SELECTION

(**W_H**, **B_K**, **M_O**, **B_W**, **□**, **□**, **◀**, **▶**, **▲**, **▼** and **?**)

A scene gradually appears on a black, white, or black-and-white screen or mosaic pattern (Fade-in or Wipe-in); or disappears, leaving a black, white, or black-and-white screen or mosaic pattern (Fade-out or Wipe-out).

Fade or Wipe works when recording is started or when you stop recording.

Before the following step, perform the above steps 1 through 3.

4 START OR END RECORDING

Press the Recording Start/Stop Button to activate Fade-in/out or Wipe-in/out.

NOTE:

☞ pg. 26.

[Ex.: **W_H** FADER - WHITE]

Fade-in



Fade-out

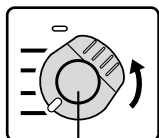
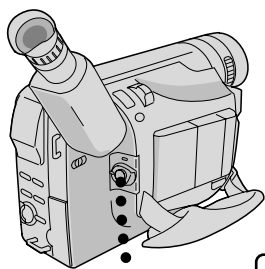

Recording Start/Stop Button

Previous scene end



[Ex.: P WIPE – SCROLL]

Within 5 minutes . . .



Wipe-in

PICTURE WIPE OR DISSOLVE SELECTION

(P, P, P, P, P, P and P)

Combine the Picture Wipe and Dissolve functions for a professional transition effect. There are 6 Picture Wipe effects and 1 Dissolve effect. The Picture Wipe or Dissolve works when recording is started.

Before the following steps, perform steps 1 through 3 on pg. 25.

4 STORE SCENE IN MEMORY

Engage the Record-Standby mode.

If you select Picture Wipe/Dissolve during recording . . .

.... press the Recording Start/Stop Button when one scene is finished. The point at which the scene ended is stored in memory.

If you select Picture Wipe/Dissolve during Record-Standby mode . . .

.... press the Recording Start/Stop Button to start recording and press it again when one scene is finished. The point at which the scene ended is stored in memory.

If you select Picture Wipe/Dissolve during Record-Standby mode after performing a Picture Wipe/Dissolve . . .

.... the point at which the scene ended is already stored in memory.

























5 START RECORDING

If you start recording a new scene within 5 minutes of the end of the previous recording (without having turned the camcorder's power off), the previous scene wipes out, revealing the new scene.

NOTES:

- You can extend the length of a Fade or Wipe by pressing and holding the Recording Start/Stop Button.
- If the power is turned off after a scene is finished recording, the stored point is erased. This disables the Picture Wipe/Dissolve combination. When this happens, the Picture Wipe/Dissolve indicator blinks. Try recording again, but do not turn the power off when you are finished. Please be advised that power also shuts off automatically if 5 minutes elapse in the Record-Standby mode.
- The sound at the end of the last recorded scene is not stored.

Fader And Wipe Menu

Menu	Effect
 FADER — WHITE	Fade in or out with a white screen.
 FADER — BLACK	Fade in or out with a black screen.
 FADER — MOSAIC	Fade in or out with a full-screen mosaic effect.
 FADER — B.W	Fade in to a colour screen from a black and white screen, or fade out from colour to black and white.
 WIPE — CORNER	Wipe in on a black screen from the upper right to the lower left corner, or wipe out from lower left to upper right, leaving a black screen.
 WIPE — WINDOW	The scene starts in the centre of a black screen and wipes in towards the corners, or comes in from the corners, gradually wiping out to the centre.
 WIPE — SLIDE	Wipe in from right to left, or wipe out from left to right.
 WIPE — DOOR	Wipe in as the two halves of a black screen open to the left and right, revealing the scene, or wipe out and the black screen reappears from left and right to cover the scene.
 WIPE — SCROLL	The scene wipes in from the bottom to the top of a black screen, or wipes out from top to bottom, leaving a black screen.
 WIPE — SHUTTER	Wipe in towards the centre of a black screen from the top and bottom, or wipe out from the centre towards the top and bottom, leaving a black screen.
 P DISSOLVE	The new scene gradually appears as the old one gradually disappears.
 P WIPE — CORNER	The new scene wipes in over the previous one from the upper right corner to the lower left corner.
 P WIPE — WINDOW	The next scene gradually wipes in from the centre of the screen towards the corners, covering the previous scene.
 P WIPE — SLIDE	The next scene gradually wipes in over the previous one from right to left.
 P WIPE — DOOR	The previous scene wipes out from the centre to the right and left, like a door being pushed open to reveal the next scene.
 P WIPE — SCROLL	The new scene wipes in over the last one from the bottom of the screen to the top.
 P WIPE — SHUTTER	The new scene wipes in over the previous one from the centre towards the top and bottom of the screen.
 RANDOM	When this function is activated, the camcorder randomly selects the effect used in scene transition (from Wh , Bk ,  ,  ,  ,  ,  ,  and ). The Picture Wipe/Dissolve function is not available.

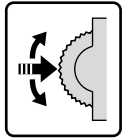
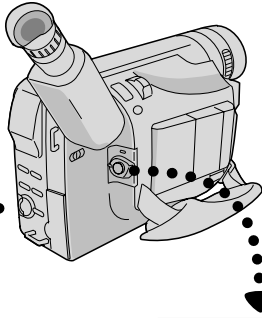

Select Dial

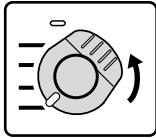

Power Switch

Display

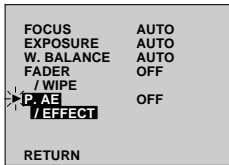

Manual Mode Item Menu

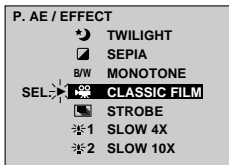

P.AE/EFFECT Menu

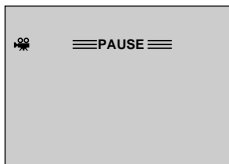

The indicator for the selected mode appears, and the selected mode is engaged.

Programme AE With Special Effects

IMPORTANT:

If certain Fades or Wipes (pg. 27) are activated, some modes of Programme AE with special effects cannot be used. If you select a mode that is unusable in the current situation, the mode's symbol blinks.

You can choose any one of the effects from the P.AE/EFFECT Menu.

1 SELECT OPERATION MODE

Set the Power Switch to "PRO."

2 ACCESS MANUAL MODE ITEM MENU

Press the Select Dial and move the highlight bar to "P.AE/EFFECT" by rotating the Select Dial.

3 ACCESS P.AE/EFFECT SELECT MENU

Press the Select Dial. The P.AE/EFFECT Menu appears.

4 SELECT MODE

Move the highlight bar to the desired mode by rotating the Select Dial, then press it.

- The P.AE/EFFECT Menu disappears and the selected mode is activated. The symbol of the selected mode appears.

5 DISABLE MODE

To turn off the selected mode, re-access the P.AE/EFFECT Menu and move the highlight bar to "OFF" by rotating the Select Dial. Then press it.

NOTE:

Programme AE with special effects can be changed during recording or during Record-Standby.



SHUTTER (Variable Shutter Speed)

1/50—The shutter speed is fixed at 1/50th of a second. Black bands that usually appear when shooting a TV screen become narrower.

1/100—The shutter speed is fixed at 1/100th of a second. The flickering that occurs when shooting under a fluorescent light or mercury-vapour lamp is reduced.

1/250, 1/500—These settings allow fast-moving images to be captured one frame at a time, for vivid, stable slow-motion playback. The faster the shutter speed, the darker the picture becomes. Use the shutter function under good lighting conditions.

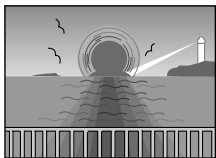

TWILIGHT

Makes evening scenes look more natural. White Balance (☞ pg. 34) is initially set to , but can be changed to your desired setting. When Twilight is chosen, the camcorder automatically adjusts the focus from approx. 10 m to infinity. From less than 10 m, adjust the focus manually.



SEPIA

Recorded scenes have a brownish tint like old photos. Combine this with the Cinema mode for a classic look.

B/W MONOTONE

Like classic black and white films, your footage is shot in B/W. Used together with the Cinema mode, it enhances the “classic film” effect.



CLASSIC FILM

Gives recorded scenes a strobe effect.



STROBE

Your recording looks like a series of consecutive snapshots.

SLOW (Slow Shutter)

You can light dark subjects or areas even brighter than they would be under good natural lighting.

1 SLOW 4X

The Shutter Speed is set to 1/12.5th of a second to quadruple the sensitivity.

2 SLOW 10X

The Shutter Speed is set to 1/5th of a second to provide 10 times the sensitivity.

NOTES:

- When using “SLOW”, the image takes on a strobe-like effect.
- Use “SLOW” only in dark areas.
- The Manual Focus indication may appear and flash when “SLOW” is in use.
- If the image is out of focus, adjust manually. It is also recommended that you use a tripod, if possible.

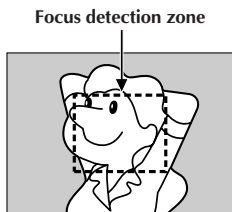

Focusing

AUTO FOCUS

The camcorder's Full Range AF system offers continuous shooting ability from close-up (as close as approx. 1.5 cm to the subject) to infinity. However, correct focus may not be obtainable in the situations listed below (in these cases use manual focusing):

- When two subjects overlap in the same scene.
- When illumination is low.*
- When the subject has no contrast (difference in brightness and darkness), such as a flat, one-colour wall, or a clear, blue sky.*
- When a dark object is barely visible in the viewfinder.*
- When the scene contains minute patterns or identical patterns that are regularly repeated.
- When the scene is affected by sunbeams or light reflecting off the surface of a body of water.
- When shooting a scene with a high-contrast background.

* The following low-contrast warnings appear blinking:

▲, ▲, ▼ and 👤

NOTES:

- If the lens is smeared or blurred, accurate focusing is not possible. Keep the lens clean, wiping with a piece of soft cloth if it gets dirty. When condensation occurs, wipe with a soft cloth or wait for it to dry naturally.
- When shooting a subject close to the lens, zoom-out first (☞ pg. 16). If zoomed-in in the auto focus mode, the camcorder could automatically zoom out depending on the distance between the camcorder and the subject. When "TELE MACRO" (☞ pg. 23) is activated, the camcorder will not zoom out automatically.

MANUAL FOCUS

NOTE:

You should already have made the necessary viewfinder adjustments (☞ pg. 12). If you have not, do so before continuing.

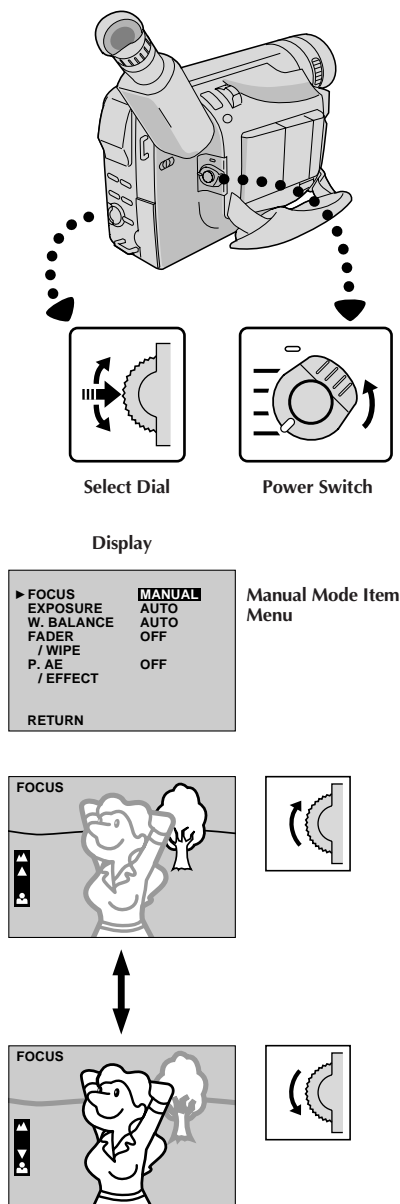
**1 SELECT OPERATION MODE**

Set the Power Switch to "PRO."

2 ACCESS MANUAL MODE ITEM MENU

Press the Select Dial. The Manual Mode Item Menu appears.

3 ACCESS MANUAL FOCUS

Move the highlight bar to "FOCUS" by rotating the Select Dial, then press it. Rotate the Select Dial to display "MANUAL", then press it. The Manual Mode Item Menu disappears and "FOCUS" is displayed in the upper left corner. The focus is locked at this point.

4 ADJUST FOCUS

To farther subject . . .

.... rotate the Select Dial upward. "▲" appears and blinks. Go to step 5.

To nearer subject . . .

.... rotate the Select Dial downward. "▼" appears and blinks. Go to step 5.

5 END ADJUSTMENT OF FOCUS

Press the Select Dial. Focus adjustment is complete. The indication changes from "FOCUS" to "PRO."

• If you want to reset the focus, repeat from step 2.

To Change To Auto Focus . . .

.... rotate the Select Dial to display "AUTO" then press it in step 3. The manual focus indicators disappear. Or set the Power Switch to "AUTO".

NOTES:

- After the Power Switch is set to "OFF", Manual Focus is reset to "AUTO".
- Be sure to focus the lens in the maximum telephoto position when you use the Manual Focus mode. If you focus in on a certain subject in the wide-angle position, sharply focused images cannot be obtained when zoomed up because the depth-of-field is reduced at longer focal lengths.
- When the focus level cannot be adjusted any farther or closer, "▲" or "▼" will blink.

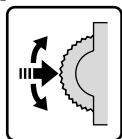
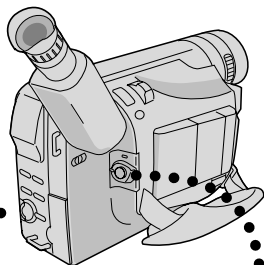

Select Dial

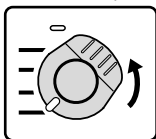

Power Switch

Display

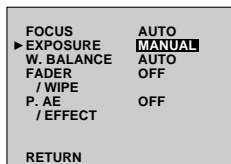

Manual Mode Item Menu



To darken the image



To brighten the image

Exposure control indicator

Exposure Control

This feature automatically adjusts the iris for the best available picture quality, but you can override and make the adjustment manually.

1 SELECT OPERATION MODE

Set the Power Switch to "PRO."

2 ACCESS MANUAL MODE ITEM MENU

Press the Select Dial. The Manual Mode Item Menu appears.

3 ACCESS EXPOSURE CONTROL

Move the highlight bar to "EXPOSURE" by rotating the Select Dial, then press it. Rotate the Select Dial to display "MANUAL", then press it. The Manual Mode Item Menu disappears. "EXP." and the highlight bar on the exposure control indicator are displayed.

4 ADJUST EXPOSURE

To brighten the image . . .

.... rotate the Select Dial upward. The exposure control indicator increases (maximum +6).

Go to step 5.

To darken the image . . .

.... rotate the Select Dial downward. The exposure control indicator decreases (maximum -6).

Go to step 5.

5 END ADJUSTMENT OF EXPOSURE

Press the Select Dial. Exposure adjustment is complete. The indication "EXP." changes to "PRO." and the highlight bar on the exposure control indicator goes out.

• If you want to reset the exposure, repeat step 2.

To Return To Automatic Exposure Control . . .

.... rotate the Select Dial to display "AUTO" then press it in step 3. The exposure control indicator disappears. Or set the Power Switch to "AUTO".

NOTES:

- After the Power Switch is set to "OFF", Exposure Control is reset to "AUTO".
- Manual exposure adjustment is recommended in the following situations:
 - When shooting using reverse lighting or when the background is too bright.
 - When shooting on a reflective natural background such as at the beach or when skiing.
 - When the background is overly dark or the subject light.

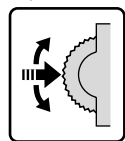
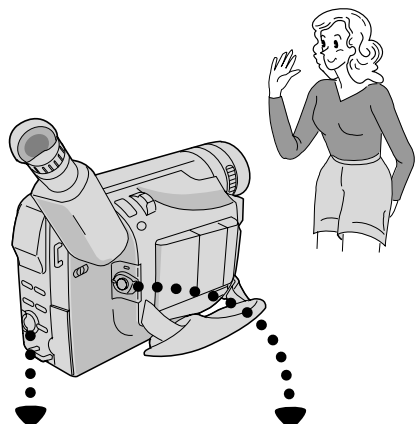

Select Dial

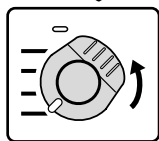

Power Switch

Display

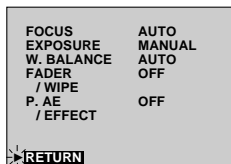

Manual Mode Item Menu



Iris lock indicator

Iris Lock

Use this function when shooting a moving subject, when zooming, when the subject changes its distance (thus its size in the viewfinder), or when you want to lock the brightness level.

When the subject is close, keep the iris locked. Even when the subject moves away from you, the image will not darken or brighten.

- 1 SELECT OPERATION MODE**
Set the Power Switch to "PRO."
- 2 ACCESS MANUAL MODE ITEM MENU**
Press the Select Dial. The Manual Mode Item Menu appears.
- 3 ACCESS EXPOSURE CONTROL**
Move the highlight bar to "EXPOSURE" by rotating the Select Dial and then press it. Rotate the Select Dial to display "MANUAL", then press it. "EXP." is displayed.
- 4 CENTRE SUBJECT, LOCK IRIS**
Adjust zoom so that the subject fills the viewfinder, then press and hold the Select Dial for over 2 seconds. The exposure control indicator and "□" appear, indicating that the iris is locked. Press the Select Dial. The indication displayed in the upper left corner changes from "EXP." to "PRO."

To Return To Automatic Iris Control . . .

.... rotate the Select Dial to display "AUTO" then press it in step 3. The exposure control indicator and "□" disappear. Or set the Power Switch to "AUTO".

NOTE:

Iris lock is recommended in the following situations:

- When shooting on a reflective natural background such as at the beach or when skiing.
- When shooting objects under a spotlight.
- When the subject is backing away.
- When zooming.

To Lock The Exposure Control And The Iris . . .

.... after step 3, adjust the exposure rotating the Select Dial. Then lock the iris in step 4. For automatic locking, rotate the Select Dial to display "AUTO", then press it in step 3. The iris becomes automatic after about 2 seconds.

Iris

Works like the pupil of the human eye. In a well-lit environment, the human pupil contracts to keep too much light from entering. In low lighting, the pupil dilates to allow more light in.

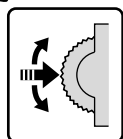
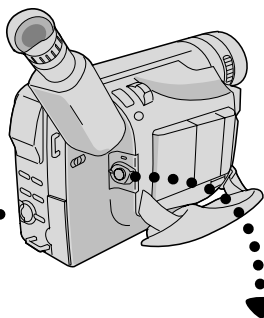

Select Dial

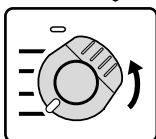

Power Switch

Display

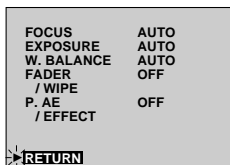

Manual Mode Item Menu

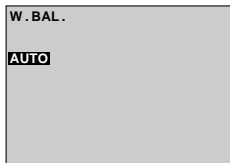
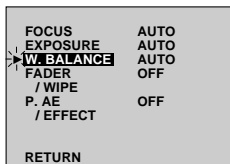

White Balance Adjustment

White Balance Adjustment

A term that refers to the correctness of colour reproduction under various lighting. If the white balance is correct, all other colours will be accurately reproduced.

The white balance is usually adjusted automatically. However, the more advanced camcorder operator would prefer to control this function manually and achieve a more professional colour/tint reproduction.

1 SELECT OPERATION MODE

Set the Power Switch to "PRO."

2 ACCESS MANUAL MODE ITEM MENU

Press the Select Dial. The Manual Mode Item Menu appears.

3 ACCESS WHITE BALANCE ADJUSTMENT

Move the highlight bar to "W.BALANCE" by rotating the Select Dial. Then press it. The Manual Mode Item menu disappears and "W.BAL." appears in the upper left corner and "AUTO" appears on the screen.

4 SET FUNCTION PARAMETERS

Cycle through the available settings of the selected functions by rotating the Select Dial, and stop when the one you want is displayed.

"AUTO" – The white balance is adjusted automatically. This is the factory preset position.

"☑" – When shooting with the white balance already having been set on the subject (☞ pg. 35).

"☀" – When shooting outdoors on a sunny day.

"☁" – When shooting outdoors on a cloudy day.

"☹" – When using a video light or other similar type of lighting.

5 CLOSE WHITE BALANCE ADJUSTMENT

Press the Select Dial again. Selection is complete. The indication "W. BAL." changes to "PRO."

To Return To Automatic White Balance . . .

.... select "AUTO" in step 3. Or set the Power Switch to "AUTO".

NOTE:

White balance cannot be used when Sepia or Monotone (☞ pg. 29) is activated.

Manual White Balance Operation

If the camera is operating in PRO. mode, perform a Manual White Balance when shooting under various types of lighting.

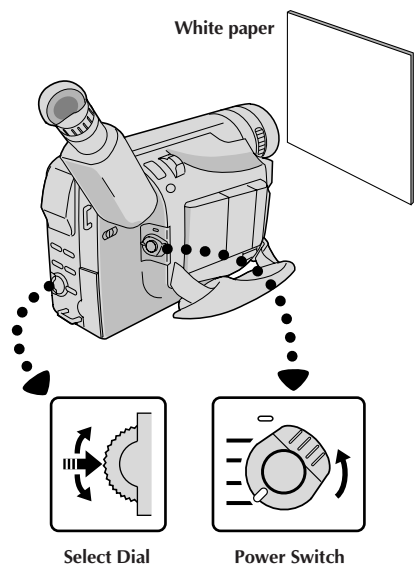

Display

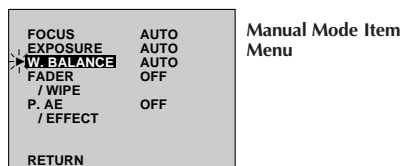

Manual White Balance Adjustment

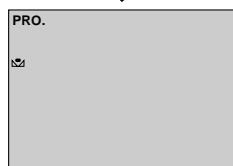

1 SELECT OPERATION MODE

Follow steps 1 through 4 of the white balance adjustment (☞ pg. 34), select “☑ MAN.”.

2 SET MANUAL WHITE BALANCE

Hold a sheet of plain white paper in front of the subject. Adjust zoom or position yourself so that the white paper fills the screen.

3 ENTER SETTING

Press the Select Dial until the ☑ begins blinking.

- When the setting is completed, the ☑ stops blinking.

4 EXIT MANUAL WHITE BALANCE ADJUSTMENT

Press the Select Dial. The indication “W.BAL.” changes to “PRO.” and only the Manual White Balance indicator ☑ is displayed.

To Change The Tint For Recording . . .

.... in step 2, substitute coloured paper for white. The white balance is adjusted based on the colour, changing the tint. Red paper — deeper green; blue paper — orange; yellow paper — deeper purple.

NOTES:

- In step 2, it may be difficult to focus on the white paper in some circumstances. In such a case, adjust focus manually (☞ pg. 31).
- A subject can be shot under various types of lighting conditions indoors (natural, fluorescent, candlelight, etc.). Because the colour temperature is different depending on the light source, the tint of the subject will differ depending on the white balance settings. Use this function for a more natural result.
- Once you adjust white balance during Manual White Balance operation, the setting is retained even if the power is turned off or the battery removed.

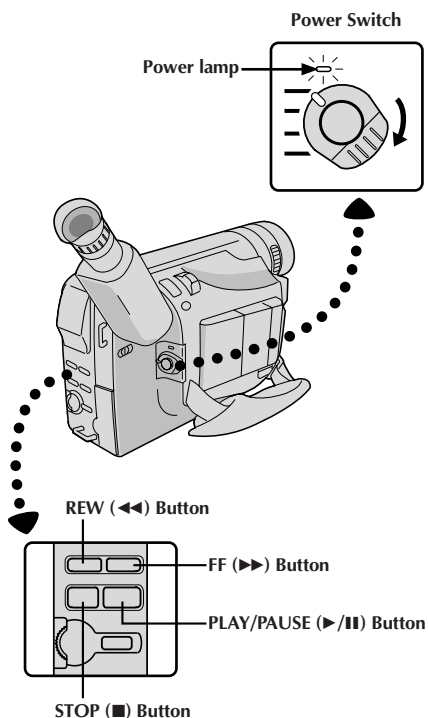
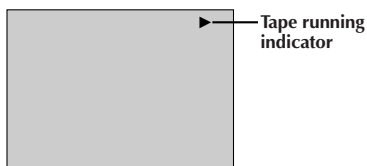
**Viewfinder Indication****1 LOAD A CASSETTE**

Press **OPEN/EJECT** in the direction of the arrow printed on it, then swing the cassette cover open until it locks. The holder opens automatically. Insert a tape and press "PUSH HERE" to close the cassette holder.

2 SELECT MODE

Set the Power Switch to "PLAY". The power lamp lights.

3 PLAY BACK

Press **PLAY/PAUSE** (▶/||). The playback picture appears.

4 STOP PLAYBACK

Press **STOP** (■).

Rewind or Fast-forward the tape

Press **REW** (◀◀) to rewind, or **FF** (▶▶) to fast-forward the tape during Stop mode.

NOTES:

- The camcorder shuts off automatically after about 5 minutes in Stop mode. To turn on again, set the Power Switch to "POWER OFF", then to "PLAY".
- Copy guarded tapes cannot be played back. The screen becomes blue back.

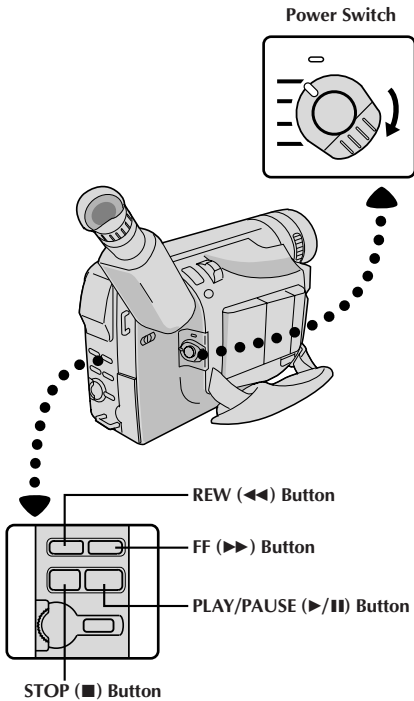

FEATURE: Still Playback

PURPOSE:

To pause during playback.

OPERATION:

- 1) Press **PLAY/PAUSE** (▶/||) during playback.
- 2) To resume normal playback, press **PLAY/PAUSE** (▶/||) again.

NOTE:

If still playback continues for more than about 3 minutes, the camcorder's Stop mode is automatically engaged. After 5 minutes in the Stop mode, the camcorder's power is automatically turned off.

FEATURE: Shuttle Search

PURPOSE:

To allow high-speed search in either direction.

OPERATION:

- 1) Press **FF** (▶▶) to forward or press **REW** (◀◀) to reverse during playback.
- 2) To resume normal playback, press **PLAY/PAUSE** (▶/||).

NOTES:

- During playback, press and hold **REW** (◀◀) or **FF** (▶▶). The search continues as long as you hold the button. Once you release it, normal playback resumes.
- A slight mosaic effect appears on screen during Shuttle Search. This is not a malfunction.

FEATURE: Slow-Motion Playback

Available only with the RM-V712U remote control (provided) (☞ pg. 45).

FEATURE: Playback Zoom

Available only with the RM-V712U remote control (provided) (☞ pg. 46).

FEATURE: Playback Special Effects

Available only with the RM-V712U remote control (provided) (☞ pg. 47).

Playback Menu

The Playback Menu allows you to set the following functions:

Playback Sound (32 kHz, 48 kHz), Synchro Comp, Display and Time Code. The following procedure applies to all except Synchro Comp (see pg. 52, 53).

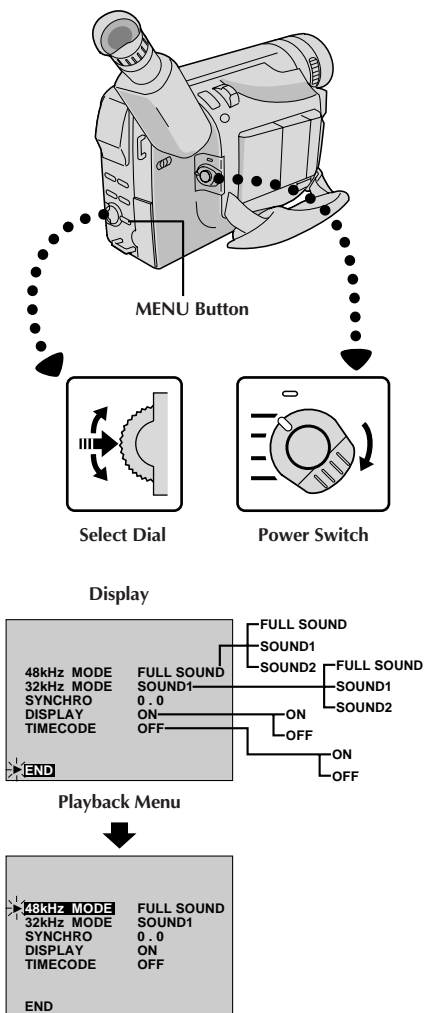

1

SELECT OPERATION MODE

Set the Power Switch to "PLAY".

2

ACCESS PLAYBACK MENU

Press MENU. The Playback Menu appears.

3

SELECT FUNCTION

Move the highlight bar to the desired function by rotating the Select Dial. Press the Select Dial to activate.

4

SET FUNCTION PARAMETERS

Rotate the Select Dial to cycle through the available settings for the selected function, and stop when the desired setting appears. Then press the Select Dial, and the highlight bar automatically moves to "END".

- To set parameters for other functions, repeat steps 3 and 4.

5

CLOSE MENU

Press the Select Dial again, and the menu disappears.

Playback Sound

During playback, the camcorder detects the sound mode in which the recording was made, and plays the sound back. Select the type of sound to accompany your playback picture. (32 kHz is preset to "SOUND 1" and 48 kHz is preset to "FULL SOUND".)

Recording sound	Display	Output sound
32 kHz	FULL SOUND	Stereo sound
	SOUND 1	
	SOUND 2	
48 kHz	FULL SOUND	Stereo sound
	SOUND 1	"L" sound is output on both channels
	SOUND 2	"R" sound is output on both channels

When watching a tape recorded at 32 kHz, if you want to change the output sound, access the Playback Menu and, in step 3 on page 38, select "32kHz MODE" and set it for "FULL SOUND", "SOUND 1" or "SOUND 2". When playing back a tape recorded at 48kHz, set in the same manner. For information on output sound during Audio Dubbing, see page 55.

NOTES:

- You can also use the provided RM-V712U remote control's **AUDIO MONITOR** button to change the output sound (without having to access the Playback Menu). Make sure you point the remote control at the camcorder's remote sensor.
- During playback, the camcorder detects the sound mode in which the recording was made. This detection cannot be made during fast-forward or rewind. During playback the sound mode is displayed in the upper left corner.

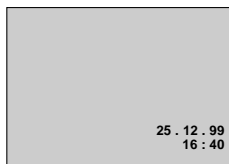
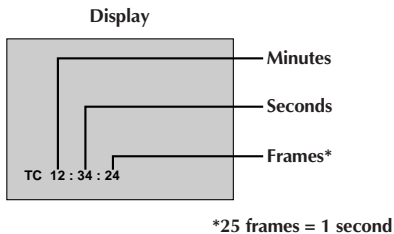

TIME CODE

(Displaying The Time Code During Playback)

You can display the Time Code on screen during playback. This is especially useful for editing. This function is preset to "OFF". To turn it on, select "TIME CODE" at the Playback Menu and change the setting (pg. 38).

- ON**– The Time Code is displayed on the playback screen.
OFF– The Time Code does not appear.

DISPLAY

(Displaying the Date During Playback)

If the time has been set, the date is automatically recorded separately from the recorded video signal. You can display or remove the date anytime during playback. This function is preset to "ON". To turn it off, select "DISPLAY" at the Playback Menu and change the setting (pg. 38).

- ON**– The date is displayed on the playback screen.
OFF– The date is not displayed.

These are some basic types of connections. When making the connections, refer also to your VCR and TV instruction manuals.

A. Connection to a TV or VCR equipped with a SCART connector compatible only with regular video signal

Use the provided Audio/Video (A/V) cable.

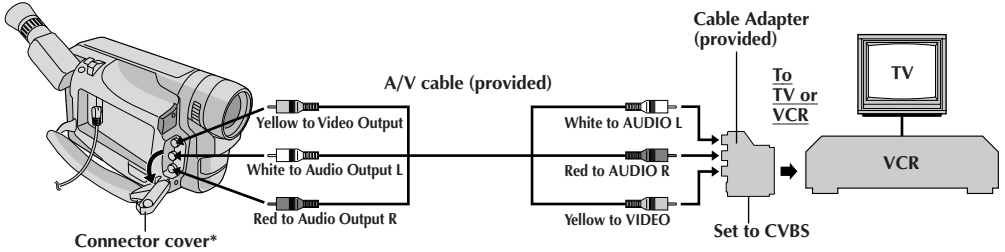

B. Connection to a TV or VCR equipped with a SCART connector compatible with Y/C signal

Use the provided Audio/Video (A/V) cable and S-Video cable.

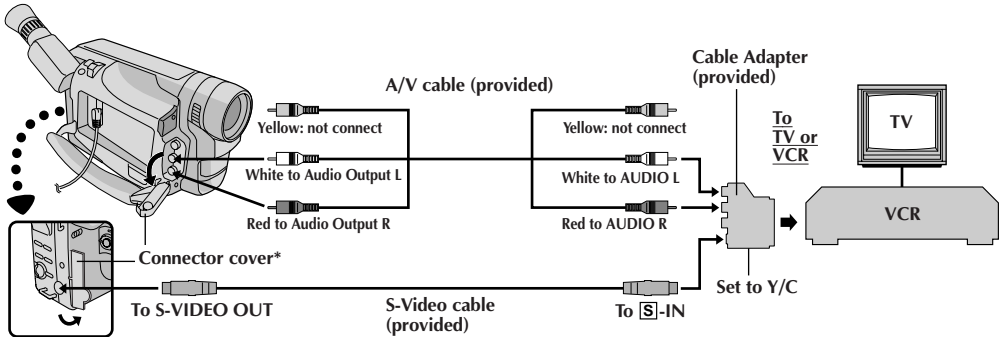

C. Connection to a TV or VCR equipped with an S-VIDEO IN and/or A/V input (RCA type) connectors

Use the provided Audio/Video (A/V) cable and S-Video cable.

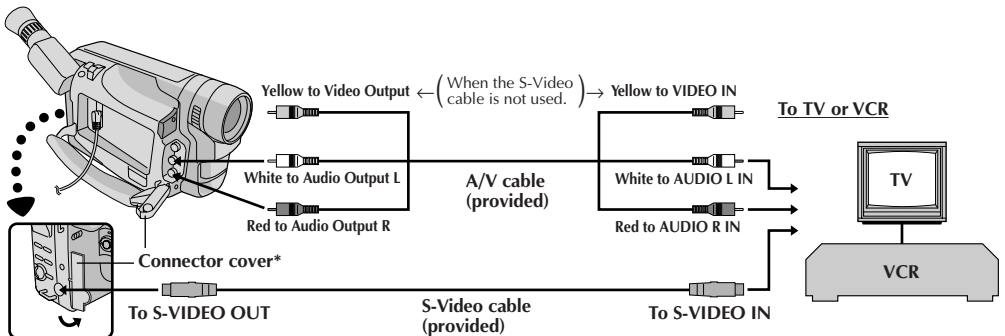

* When connecting the cables, open this cover.

1 CONFIRM POWER-OFF STATUS

Make sure the camcorder's power is off.

2 CONNECT CAMCORDER TO TV OR VCR

Pull out the connector cover and open it.
Connect as shown in the illustration (☞ pg. 40).

If Using A VCR . . . go to step 3.

If not . . . go to step 4.

3 CONNECT VCR OUTPUT TO TV INPUT

Refer to your VCR's instruction manual.

4 SUPPLY POWER

Turn on the camcorder, the VCR and the TV.

5 SELECT MODE

Set the VCR to its AUX input mode, and set the TV to its VIDEO mode.

To choose whether or not the following displays appear on the connected TV . . .

- Date/Time, Time Code
.... set to "ON" or "OFF" in the Playback Menu (☞ pg. 38).
- Playback Sound Mode Display
.... set the Power Switch to "PRO.", press **MENU**, and set "ON SCREEN" in the Date/Time Menu (☞ pg. 9) to "ON" or "OFF". Then set the Power Switch back to "PLAY".

NOTES:

- **It is recommended to use the AC Power Adapter/Charger as the power supply instead of the battery pack** (☞ pg. 7).
- To monitor the picture and sound from the camcorder without inserting a tape, set the camcorder's Power Switch to "CAMERA", then set your TV to the appropriate input mode.
- Make sure you adjust the TV sound volume to its minimum level to avoid a sudden burst of sound when the camcorder is turned on.
- If you have a TV or speakers that are not specially shielded, do not place the speakers adjacent to the TV as interference will occur in the camcorder playback picture.
- To keep the camcorder's display from appearing on the TV screen during playback, press **DISPLAY** for longer than 1 second.
- Set the video out select switch of the cable adapter as required:
Y/C: When connecting to a TV or VCR which accepts Y/C signals and uses an S-Video cable.
CVBS: When connecting to a TV or VCR which does not accept Y/C signals and uses an audio/video cable.

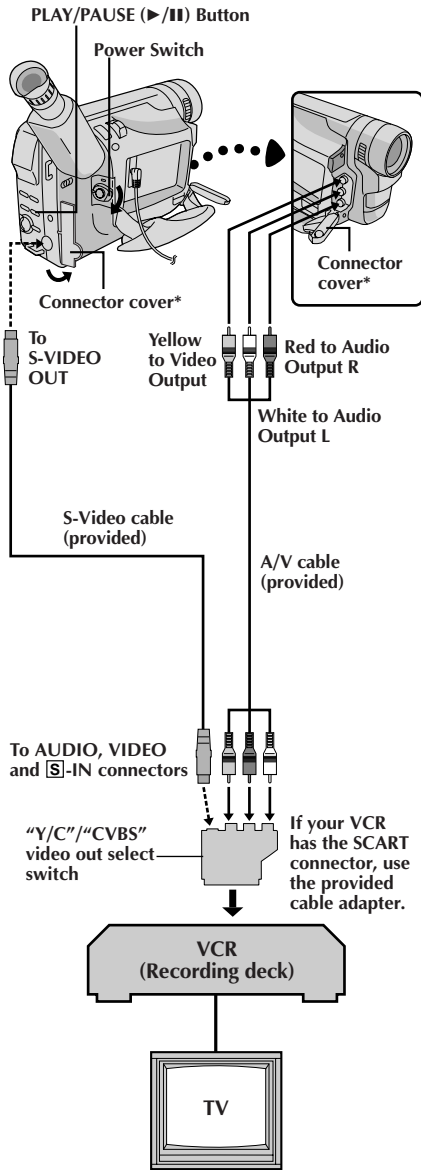

* When connecting the cables, open this cover.

Tape Dubbing

1

CONNECT EQUIPMENT

Following the illustration at left, connect the camcorder and the VCR. Also refer to pg. 40 and 41.

2

PREPARE FOR DUBBING

Set the camcorder's Power Switch to "PLAY", turn on the VCR's power, and insert the appropriate cassettes in the camcorder and the VCR.

3

SELECT VCR MODE

Engage the VCR's AUX and Record-Pause modes.

4

FIND EDIT-IN POINT

Engage the camcorder's Play mode to find a spot just before the edit-in point. Once it is reached, press **PLAY/PAUSE (▶/⏸)** on the camcorder.

5

START EDITING

Press **PLAY/PAUSE (▶/⏸)** on the camcorder and engage the VCR's Record mode.

6

STOP EDITING TEMPORARILY

Engage the VCR's Record-Pause mode and press **PLAY/PAUSE (▶/⏸)** on the camcorder.

7

EDIT MORE SEGMENTS

Repeat steps 4 through 6 for additional editing, then stop the VCR and camcorder when finished.

NOTES:

- You can use *Playback Zoom* (☞ pg. 46) or *Playback Special Effects* (☞ pg. 47) in step 5.
- Before you start dubbing, make sure that the indications do not appear on the connected TV. If they do appear during dubbing, they are being recorded onto the new tape.
To clear the Playback Sound Mode Display, press **DISPLAY** on the RM-V712U remote control (provided).
- Select "DISPLAY" and "TIME CODE" from the Playback Menu (☞ pg. 38) to show or hide the Date/Time and the Time Code on the recording.
- To show or hide all indications, press **DISPLAY** on the camcorder for longer than 1 second.
- Set the video out select switch of the cable adapter as required:
Y/C: When connecting to a TV or VCR which accepts Y/C signals and uses an S-Video cable.
CVBS: When connecting to a TV or VCR which does not accept Y/C signals and uses an audio/video cable.

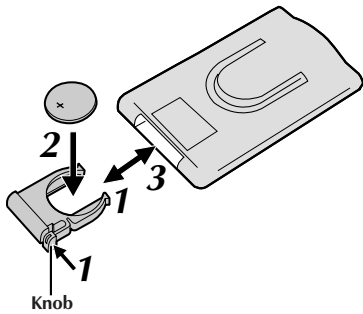

The Full-Function Remote Control Unit can operate this camcorder from a distance as well as the basic operations (Playback, Stop, Pause, Fast-Forward and Rewind) of your VCR. This remote control unit makes additional playback functions possible.

Installing The Battery

The remote control uses one lithium battery (CR2025).

- 1 PULL OUT BATTERY HOLDER**
Pull out the battery holder while pressing the knob as shown.
- 2 INSERT BATTERY IN HOLDER**
Insert the battery in the holder, and be sure to have the "+" mark visible.
- 3 RE-INSERT HOLDER**
Slide the holder back in until you hear a click.
 - Read the caution concerning lithium batteries (ⓘ pg. 2).

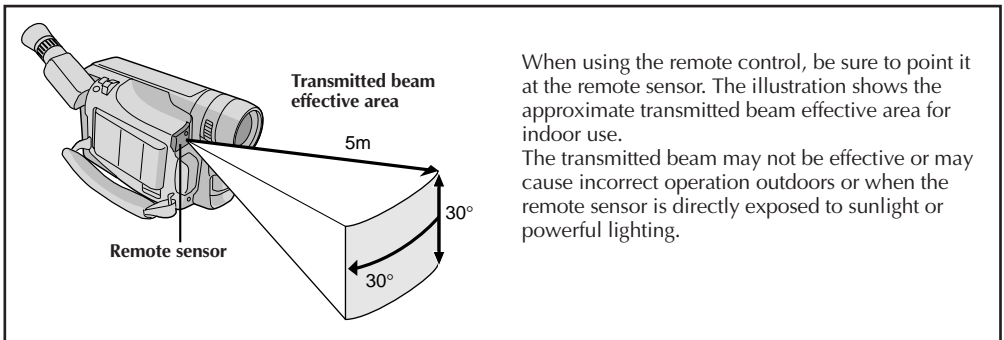

When using the remote control, be sure to point it at the remote sensor. The illustration shows the approximate transmitted beam effective area for indoor use.

The transmitted beam may not be effective or may cause incorrect operation outdoors or when the remote sensor is directly exposed to sunlight or powerful lighting.

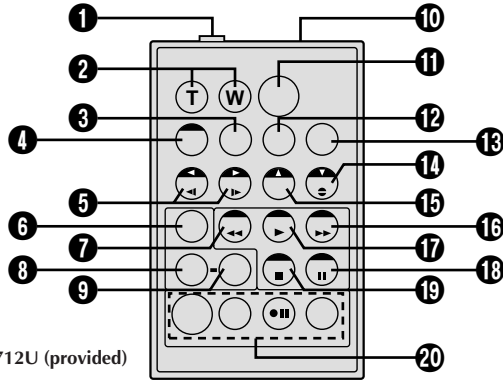

RM-V712U (provided)

Buttons	Functions	
	With the camcorder's Power Switch set to "CAMERA" ("AUTO" or "PRO.>").	With the camcorder's Power Switch set to "PLAY".
① PAUSE IN Connector	—	☞ pg. 49
② Zoom (T/W) Buttons	Zoom in/out (☞ pg. 16)	Zoom in/out (☞ pg. 46)
③ DISPLAY Button	—	☞ pg. 42
④ SHIFT Button	—	☞ pg. 46
⑤ SLOW Rewind/Forward Buttons Left/Right Buttons	— —	☞ pg. 45 ☞ pg. 46
⑥ FADE/WIPE Button	—	☞ pg. 49
⑦ REW Button	—	Rewind, Reverse Shuttle Search (☞ pg. 36, 37)
⑧ EFFECT Button	—	☞ pg. 47
⑨ EFFECT ON/OFF Button	—	☞ pg. 47
⑩ Infrared beam transmitting window	Transmits the beam signal.	
⑪ START/STOP Button	Functions same as the Recording Start/Stop button on the camcorder.	
⑫ AUDIO MONITOR Button	—	☞ pg. 39
⑬ MBR SET Button	—	☞ pg. 48
⑭ Down Button A. DUB Button	— —	☞ pg. 46 ☞ pg. 54
⑮ Up Button	—	☞ pg. 46
⑯ FF Button	—	Fast-Forward, Forward Shuttle Search (☞ pg. 36, 37)
⑰ PLAY Button	—	Playback start (☞ pg. 36)
⑱ PAUSE Button	—	Pause (☞ pg. 37)
⑲ STOP Button	—	Stop (☞ pg. 36)
⑳ R.A.EDIT Buttons	—	☞ pg. 48 – 53

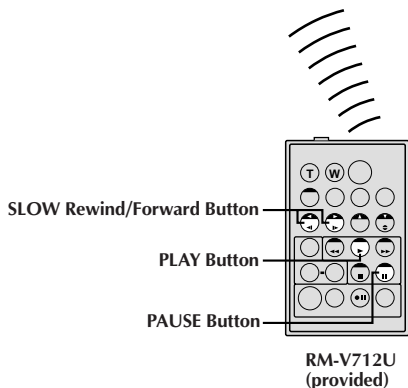
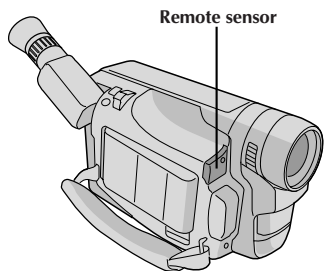

FEATURE: **Slow-Motion Playback**

PURPOSE:

To allow slow-speed search in either direction.

OPERATION:

- 1) To change from normal to Slow-Motion Playback, press **PAUSE (II)** at the point where you want to start playback in slow motion.
- 2) Press **SLOW (◀ or ▶)**. After playing back for approx. 20 seconds in Slow Rewind or approx. 60 seconds in Slow Forward, normal playback resumes.
 - To stop Slow-Motion Playback in progress, press **PLAY (▶)**.

NOTES:

- During slow-motion playback, due to digital image processing, the picture may take on a mosaic effect.
- After **SLOW (◀ or ▶)** is pressed, the still image may be displayed for a few seconds, then the screen may become blue back for a few seconds. This is not a malfunction.
- There may be a small margin between the slow-motion playback start point you chose and the start point at which the camcorder actually begins playback in slow motion.
- During Slow-motion playback, there will be disturbances in video. This is not a malfunction.

Normal playback

Press T



To move image,
press (Right)
while keeping
SHIFT held down

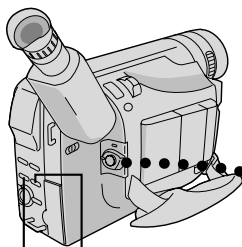

PLAY (▶) Button

STOP (■) Button

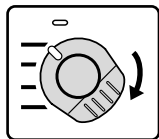

Power Switch

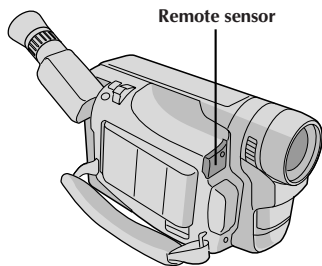

Remote sensor

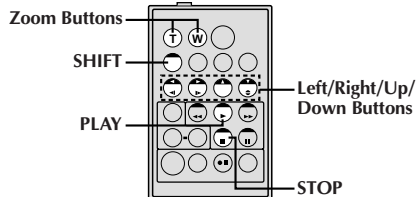

RM-V712U
(provided)

Playback Zoom

The recorded pictures can be magnified up to 10X at any time during playback.

1 FIND SCENE OF INTEREST

Press **PLAY** (▶) to start playback.

2 ACTIVATE ZOOM

Press the Zoom Buttons (T/W) on the remote control. Make sure the remote control is pointed at the camcorder's remote sensor.

- Pressing **T** zooms in.

3 END ZOOM

Press and hold **W** until magnification returns to normal. Or, press **STOP** (■) and then press **PLAY** (▶).

NOTES:

- Zoom can also be used during Slow-Motion and Still Playback.
- During digital image processing, the quality of the image may suffer.

INFORMATION

You can move the image on screen around to find a particular portion of the picture. While holding down **SHIFT**, press (Left), (Right), (Up) and (Down).

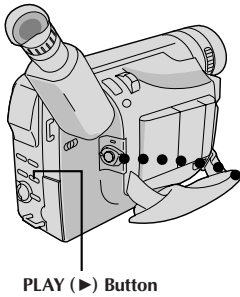

PLAY (▶) Button

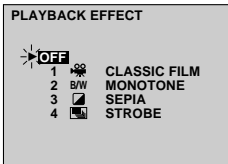
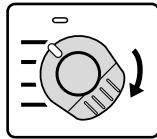
PLAYBACK EFFECT
Select Menu

Power Switch

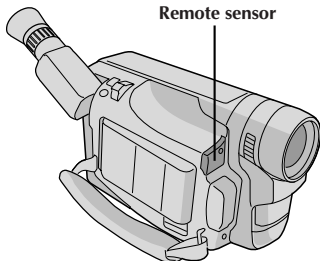

Remote sensor

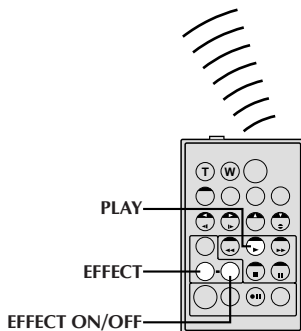

EFFECT ON/OFF

RM-V712U
(provided)

Playback Special Effects

These effects allow you to be creative with the playback picture. You can use any one of the 4 effects.

1 START PLAYBACK

Press **PLAY** (▶).

2 ACCESS PLAYBACK EFFECT SELECT MENU

Point the remote control at the camcorder's remote sensor and press **EFFECT**. The **PLAYBACK EFFECT Select Menu** appears.

3 SELECT PLAYBACK EFFECT

Move the highlight bar to the desired effect by pressing **EFFECT**. The selected function is activated and after 2 seconds the menu disappears.

NOTES:

- To deactivate the selected effect, press **EFFECT ON/OFF** on the remote control. Pressing it again re-activates the selected effect.
- Repeat from step 2 when you want to change the selected effect.
- When "MONOTONE" or "SEPIA" is activated, the "MULTI 4" and "MULTI 9" Snapshot modes (pg. 21) are not available.

The effects that can be used during playback are Classic Film, Monotone, Sepia and Strobe. The effects work the same in playback as they did in recording. Refer to page 29 for more information.

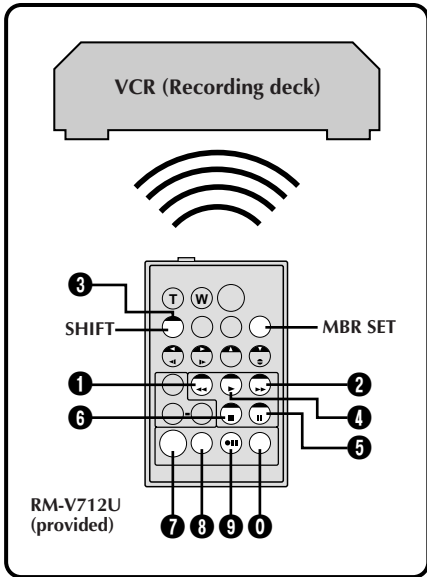

VCR CODE LIST

VCR BRAND NAME	BUTTONS (A) (B)	VCR BRAND NAME	BUTTONS (A) (B)
AKAI	6 2 7 4 7 7	PHILIPS	1 9 9 5 1 1 9 4 9 1 9 6 1 2 3 3 7 2
BLAUPUNKT	1 3	SANYO	3 6 3 5
FERGUSON	9 7 9 8 3 2	SELECO, REX	9 1 9 6
GRUNDIG	1 4 3 4	SHARP	1 5 1 0
HITACHI	6 6 6 3	SONY	6 5 6 0 3 9 3 1
JVC A B C	9 1 9 6 9 3	THOMSON, TELEFUNKEN, SABA, NORDMENDE	9 1 9 6 9 7 3 2
MITSUBISHI	6 7 6 8	TOSHIBA	6 9 6 1
NEC	3 7 3 8		
PANASONIC	1 3 1 7 1 1 9 4 1 8		

Random Assemble Editing [R.A.Edit]

Create edited videos easily using your camcorder as the source player. You can select up to 8 "cuts" for automatic editing, in any order you like. R.A.Edit is more easily performed when the RM-V712U MBR (Multi-Brand Remote, pg. 43) is set to operate with your brand of VCR (see VCR CODE LIST), but can also be performed by operating the VCR manually.

Before operation, make sure the lithium battery is installed in the remote control RM-V712U (pg. 43).

SET REMOTE/VCR CODE

1 SET REMOTE TO OPERATE VCR

Turn off the power to the VCR and point the remote towards the VCR's infrared sensor. Then, referring to the VCR CODE LIST on the left, press and hold **MBR SET**, and press button (A) and then (B).

- The code is automatically set once you release **MBR SET**, and the VCR's power comes on.

2 OPERATE VCR

Make sure the VCR's power is on. Then, while holding **SHIFT**, press the button on the remote for the desired function. The functions the remote can control are PLAY, STOP, PAUSE, FF, REW and VCR REC STBY (you do not need to press **SHIFT** for this one).

You are now ready to try Random Assemble Editing.

IMPORTANT

Although the MBR is compatible with JVC VCRs and those of many other makers, it may not work with yours or may offer limited functions.

NOTES:

- If the VCR's power does not come on in step 1, try another code from the VCR CODE LIST.
- Some brands of VCR do not come on automatically. In this case, turn the power on manually and try step 2.
- If the remote control is not able to control the VCR, use the controls on the VCR.
- When the remote control's battery runs out, the VCR brand you have set will be erased. In that case, replace the old battery with a new one to reset the VCR brand.

MAKE CONNECTIONS

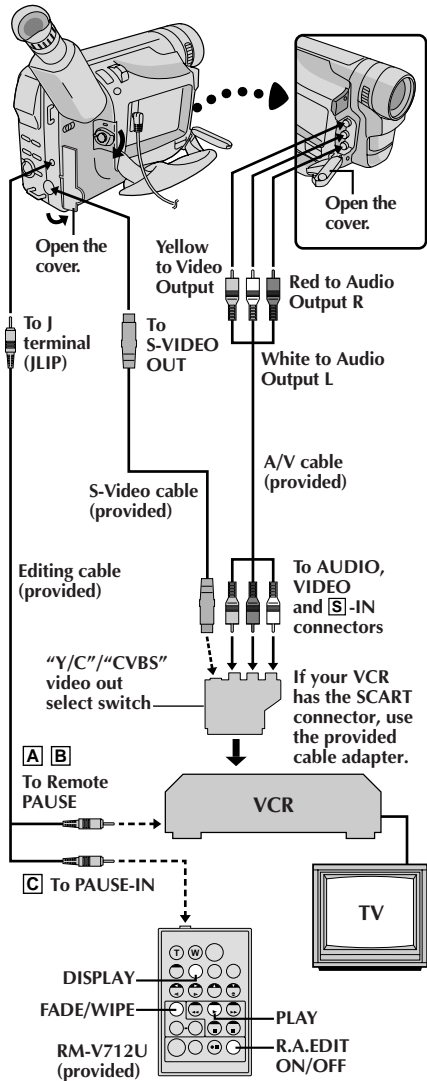
**1 CONNECT TO . . .****A JVC VCR EQUIPPED WITH REMOTE PAUSE TERMINAL**

Connect the editing cable to the Remote PAUSE terminal.

B JVC VCR NOT EQUIPPED WITH REMOTE PAUSE TERMINAL BUT EQUIPPED WITH R.A. EDIT CONNECTOR

Connect the editing cable to the R.A.EDIT connector.

C VCR OTHER THAN TYPE A OR B

Connect the editing cable to the RM-V712U's PAUSE-IN connector.

2 PREPARE CAMCORDER

Insert a recorded tape and set the Power Switch to "PLAY".

3 PREPARE VCR

Turn the power on, insert a recordable tape and engage the AUX mode (refer to VCR's instructions).

SELECT SCENES

4 START SOURCE PLAYBACK

First set the Power Switch to "PLAY". Press **PLAY** (▶) and then press **R.A. EDIT ON/OFF** on the remote control. Make sure to point the remote control at the camcorder's remote sensor.

- The Random Assemble Editing Menu appears.

5 EXECUTE FADE/WIPE IN (IF NECESSARY)

Press **FADE/WIPE** on the remote control.

- Cycle through the effects by pressing repeatedly, and stop when the one you want is displayed.
- You cannot use a Picture Wipe/Dissolve at the beginning of Programme 1.

NOTES:

- Before Random Assemble Editing, make sure the indications do not appear on the TV monitor. If they appear during Random Assemble Editing, they will be recorded onto the new tape. To clear the Playback Sound Mode Display, press **DISPLAY** on the remote control. Select "DISPLAY" and "TIME CODE" from the Playback Menu (pg. 38) to show or hide the Date/Time and the Time Code on the recording. To show or hide all indications except for the Random Assemble Editing Menu, press **DISPLAY** on the camcorder for longer than 1 second. When Random Assemble Editing starts, its indications disappear and are not recorded on the new tape.
- Set the video out select switch of the cable adapter as required:
Y/C: When connecting to a TV or VCR which accepts Y/C signals and uses an S-Video cable.
CVBS: When connecting to a TV or VCR which does not accept Y/C signals and uses an audio/video cable.

CONTINUED ON NEXT PAGE

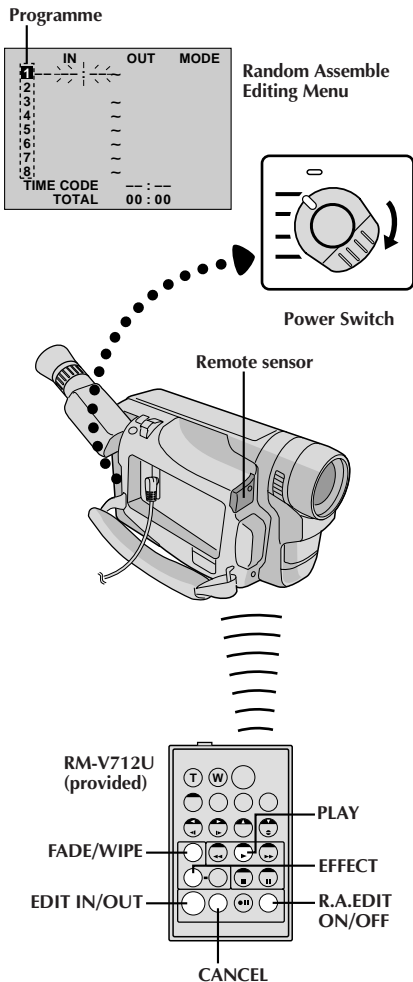

SELECT SCENES (cont.)

6 SET EDIT-IN POINT

At the beginning of the scene, press **EDIT IN/OUT** on the remote control. The Edit-In position appears on the Random Assemble Editing Menu.

7 SET EDIT-OUT POINT

At the end of the scene, press **EDIT IN/OUT**. The Edit-Out position appears on the Random Assemble Editing Menu.

8 USE FADE/WIPE ON SCENE TRANSITION (IF NECESSARY)

Press **FADE/WIPE**.

- Cycle through the effects by pressing repeatedly, and stop when the one you want is displayed.
- If you select a Fade/Wipe effect for an Edit-Out point, the effect is automatically applied to the following Edit-In point.
- You cannot use a Picture Wipe/Dissolve at the end of the last scene.
- When you use Fade/Wipe effects, that time is included in the total time (this does not apply to Picture Wipe/Dissolve).

9 USE PROGRAMME AE WITH SPECIAL EFFECTS (IF NECESSARY)

Press **EFFECT**.

- Cycle through the effects by pressing repeatedly, and stop when the one you want is displayed.
- You can use Classic Film, Monotone, Sepia or Strobe mode.

10 REGISTER ADDITIONAL SCENES

Repeat steps 6 through 9.

- To change previously registered points, press **CANCEL** on the remote control. The registered points disappear, one at a time, from the most recently registered point.
- If you are not using Fade/Wipe or Programme AE with special effects, repeat steps 6 and 7 only.

NOTES:

- When the source tape has more than 2 identical time codes (see pg. 18), the camcorder may not find the Edit-In point you chose and a malfunction may occur.
- When choosing a scene, set Edit-In and Edit-Out points so that there is a relatively large difference between them.
- If the search time for an in-point exceeds 5 minutes, the recording deck's Record-Standby mode will be cancelled and editing will not take place.
- If there are blank portions before or after the Edit-In and Edit-Out points, a blue-backed screen may be included in the edited version.
- Since time codes register time only as accurately as seconds, the time code total time may not match the total programme time exactly.
- Turning off the camcorder's power erases all registered Edit-In and Edit-Out points.
- If you select Sepia or Monotone mode from Programme AE with special effects, you cannot use the Dissolve or Black & White Fader. In this case the Dissolve or Black & White indicator begins blinking. Once the next Edit-In point is registered, the effect is turned off. To combine these effects, use Sepia or Monotone during recording, then use Dissolve or Black & White Fader during Random Assemble Editing.

AUTOMATIC EDITING TO VCR

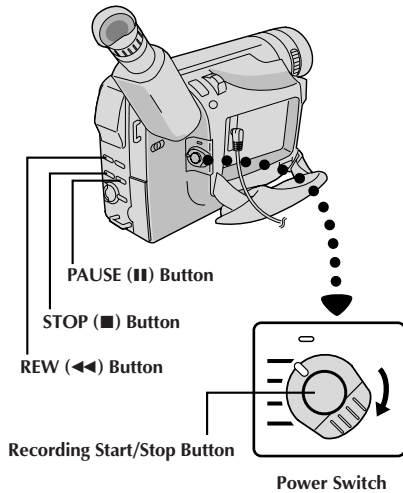

	IN	OUT	MODE
1	00:25 ~ 02:05		
2	07:18 ~ 08:31		
3	03:33 ~ 05:53		
4	09:30 ~ 13:15		
5	15:55 ~ 16:20		
6			
7			
8			
	TIME CODE	16:30	
	TOTAL	9:39	

Random Assemble Editing Menu

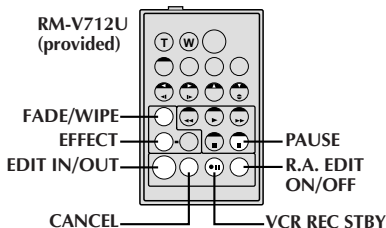
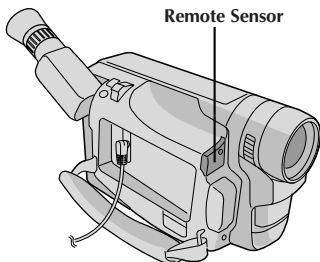
**11 PREPARE SOURCE TAPE**

Rewind the tape in the camcorder to the beginning of the scene you want to edit and press **PAUSE (II)**.

12 ENGAGE VCR'S RECORD-PAUSE MODE

Point the remote control towards the VCR's remote sensor and press **VCR REC STBY (● II)**, or manually engage the VCR's Record-Pause mode.

13 START EDITING

Press the Recording Start/Stop Button on the camcorder. Editing proceeds as programmed, right through to the end of the last registered scene.

- Pressing **START/STOP** on the remote control does not start editing.
- When dubbing is complete, the camcorder enters the Pause mode, and the recording deck enters its Record-Standby mode.
- If you do not register an Edit-Out point, the tape will be dubbed all the way to the end automatically.

14 STOP EDITING

Engage the Stop modes for the camcorder and the VCR.

To make the R.A. Edit counter display disappear, press **R.A. EDIT ON/OFF** on the remote control.

NOTES:

- Pressing **R.A. EDIT ON/OFF** on the remote control clears all settings registered during Random Assemble Editing.
- When the editing cable is connected to the Pause terminal during dubbing, make sure the remote control is pointed at the VCR's sensor, and that the path between the two is unobstructed.
- Random Assemble Editing may not function properly when using a tape including several duplicated Time Codes (pg. 18).

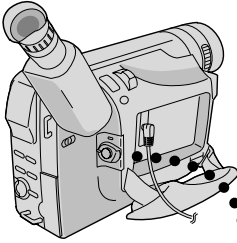

Programme 1

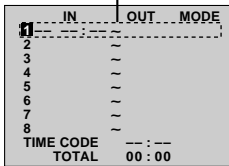

Random Assemble Editing Menu

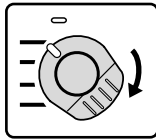

Power Switch

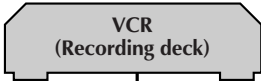
VCR
(Recording deck)

TV

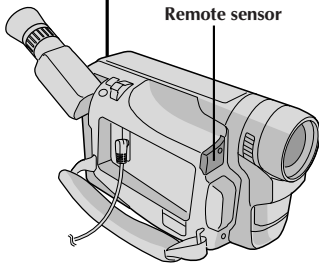

Remote sensor

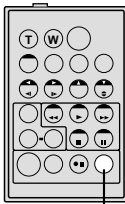
RM-V712U
(provided)

R.A.EDIT ON/OFF

For More Accurate Editing

Some VCRs make the transition from Record-Standby to Record mode faster than others. Even if you begin editing for the camcorder and the VCR at exactly the same time, you may lose scenes you wanted, or find that you have recorded scenes you did not want. For a cleanly edited tape, confirm and adjust the timing of the camcorder against your VCR.

DIAGNOSING VCR'S AGAINST CAMCORDER TIMING

1

PREPARE FOR R.A. EDIT

Play back the tape in the camcorder, then point the remote control at the camcorder's remote sensor and press **R.A. EDIT ON/OFF**.

- "Random Assemble Editing Menu" appears.

2

CHOOSE A SCENE

Perform Random Assemble Editing on Programme 1 only. In order to check VCR and camcorder timing, select the beginning of a scene transition as your Edit-In point.

3

PLAY BACK DUBBED SCENE

- If any images from the scene prior to the transition you chose for your Edit-In point were recorded, that means your VCR moves quickly from Record-Pause to Record mode.
- If the scene you tried to dub starts in progress, the VCR is slow to start recording.

ADJUSTMENT OF VCR'S AGAINST CAMCORDER TIMING

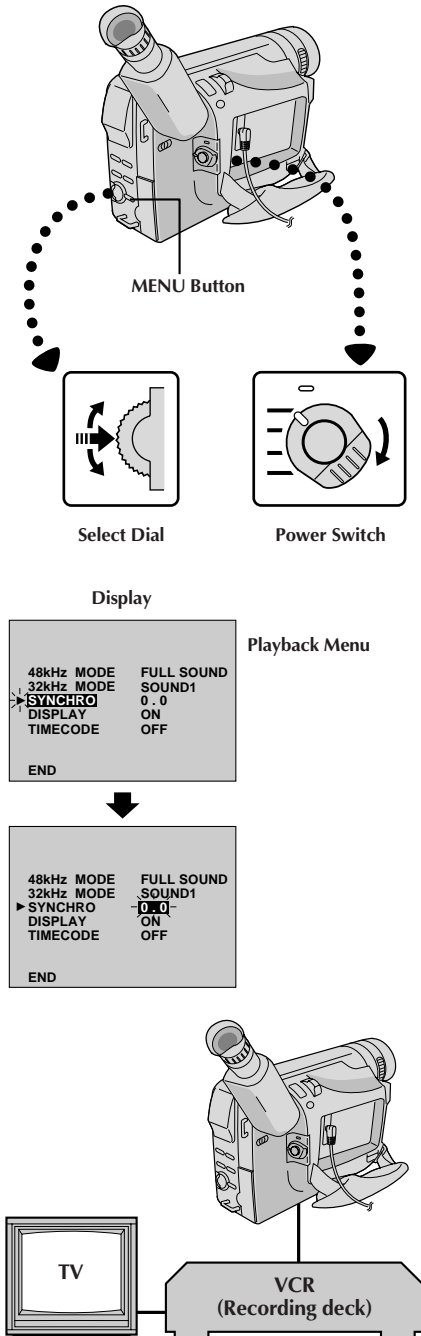

4 ACCESS PLAYBACK MENU

Point the remote control at the camcorder's remote sensor and press **R.A. EDIT ON/OFF** to make the Random Assemble Editing menu disappear, then press **MENU**. The Playback Menu appears.

5 SELECT FUNCTION

Move the highlight bar to "SYNCHRO" by rotating the Select Dial, then press it. The value for "SYNCHRO" is highlighted.

6 INPUT CORRECTION DATA

Based on the diagnostics performed (pg. 52), you can now increase the VCR's speed by rotating the Select Dial upward. You can also slow down the VCR's speed by rotating the Select Dial downward. The adjustment range is from -1.3 to +1.3 seconds, in 0.1-second increments.

7 CLOSE MENU

Press the Select Dial twice.

- Now perform Random Assemble Editing beginning with step 3 on page 49.

NOTES:

- Before performing actual Random Assemble Editing, do a few Random Assemble Editing trial runs to check whether the value you have input is appropriate or not, and make adjustments accordingly.
- Depending on the recorder, there may be situations where the timing difference cannot be fully corrected.

Display

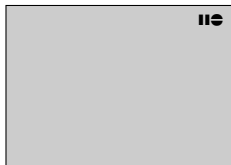
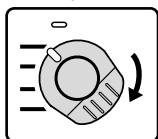
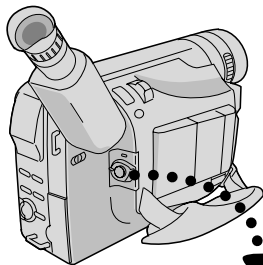
Audio Dub
Standby Mode

Power Switch

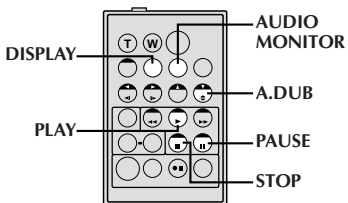
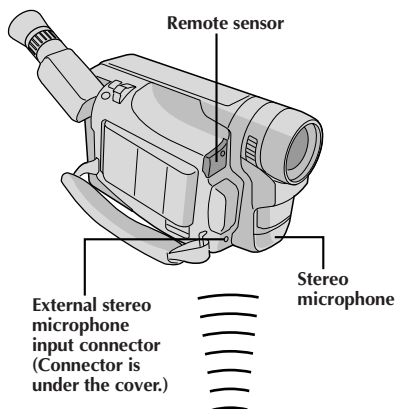
RM-V712U
(provided)

Audio Dubbing

The audio track can be customized only when recorded on the 32 kHz mode (☞ pg. 24).

NOTES:

- Audio Dubbing is not possible on a tape recorded at 48 kHz, on a tape recorded in the LP mode or on a blank portion of a tape.
- To perform Audio Dubbing while watching in the television, make connections (☞ pg. 40).

1 FIND EDIT-IN POINT

Play back the tape to locate the point where editing will start, then press PAUSE (II).

2 ENGAGE AUDIO DUB STANDBY

While holding A. DUB (⊖) on the remote control, press PAUSE (II). "II⊖" appears.

3 BEGIN DUBBING

Press PLAY (▶), then begin "narrating".

- Speak into the microphone.

4 PAUSE DURING DUBBING

Press PAUSE (II).

5 STOP DUBBING

Press STOP (■).

NOTES:

- Audio dubbing is possible using an optional microphone connected to the external microphone input connector (MIC).
- While an optional microphone is connected, the built-in microphone is disabled.
- When editing onto a tape that was recorded at 32 kHz, the old and new soundtracks are recorded separately.
- To select the desired sound for playback, press **AUDIO MONITOR** on the remote control.
- If you dub onto a blank space on the tape, the sound may be disrupted. Make sure you only edit recorded areas.
- If feedback or howling occurs during TV Playback, move the camcorder's microphone away from the TV, or turn down the TV's volume.
- If you change from 32 kHz to 48 kHz in mid-recording and then use the tape for Audio Dubbing, it is not effective from the point where 48 kHz recording began.
- During Audio Dubbing, when the tape moves to scenes recorded in the LP mode, scenes recorded at 48 kHz or a blank portion, Audio Dubbing stops and "ERROR! REFER MANUAL" appears.

Recording sound	Display	Output sound
32 kHz	FULL SOUND	Original and new tracks are combined and output in stereo.
	SOUND 2	New track is output on both "L" and "R" channels in stereo.
	SOUND 1	Original track is output on both "L" and "R" channels in stereo.

If, after following the steps in the chart below, the problem still exists, please consult your nearest JVC dealer.

The camcorder is a microcomputer-controlled device. External noise and interference (from a TV, a radio, etc.) might prevent it from functioning properly. In such cases, first disconnect its power supply unit (battery pack, AC Power Adapter/Battery Charger, etc.) and remove the clock battery; and then re-connect it and proceed as usual from the beginning.

SYMPTOM	POSSIBLE CAUSES	CORRECTIVE ACTION
1. No power is supplied.	1. • The power is not connected properly. • The battery is dead.	1. • Connect the AC Power Adapter/Charger securely (☞ pg. 7). • Replace the dead battery with a fully charged one (☞ pg. 6).
2. "SET DATE/TIME!" appears.	2. • The clock lithium battery is either not installed or has discharged. • The previously set date/time is erased.	2. • Install a battery or replace the old battery with a new one (☞ pg. 8).
3. Recording cannot be performed.	3. • The tape's record safety tab is set to "SAVE". • The Power Switch is set to "PLAY". • "TAPE END" appears. • The cassette's cover is open.	3. • Set the tape's record safety tab to "REC" (☞ pg. 10). • Set the Power Switch to "AUTO" or "PRO." (☞ pg. 14). • Replace with new cassette (☞ pg. 10). • Close the cassette's cover.
4. There is no playback picture.	4. • The camcorder is not getting power, or some other malfunction exists.	4. • Turn the camcorder's power off and on again (☞ pg. 14).
5. Some functions are not available using MENU.	5. • The Power Switch is set to "AUTO".	5. • Set the Power Switch to any position except "AUTO" (☞ pg. 14).
6. During shooting, some functions are not available using the Select Dial.	6. • The Power Switch is set to "AUTO".	6. • Set the Power Switch to "PRO." (☞ pg. 14).
7. The focus does not adjust automatically.	7. • Focus is set to "MANUAL". • The recording was done in a dark place, or the contrast was low. • The lens is dirty or covered with condensation.	7. • Set Focus to "AUTO" (☞ pg. 31). • Clean the lens and check the focus again (☞ pg. 61).
8. The cassette will not load properly.	8. • The cassette is in the wrong position. • The battery's charge is low.	8. • Set it in the right position (☞ pg. 10). • Install a fully charged battery (☞ pg. 6).
9. Play, Rewind and Fast-Forward functions do not work.	9. • The Power Switch is not set to "PLAY".	9. • Set the Power Switch to "PLAY" (☞ pg. 36).

SYMPTOM	POSSIBLE CAUSES	CORRECTIVE ACTION
<p>17. The Picture Wipe and Dissolve functions do not work.</p>	<p>17.</p> <ul style="list-style-type: none"> • The last selected editing scene is ending. • At the end of the last selected scene for editing, the Power Switch was set to "OFF". • The power is off. 	<p>17.</p> <ul style="list-style-type: none"> • Select Picture Wipe or Dissolve before beginning recording. The effects are then automatically activated (☞ pg. 26). • Do not turn off the camcorder's power after setting Edit-In and Edit-Out points, as they will all be erased (☞ pg. 26). • The camcorder automatically shuts off after 5 minutes have elapsed in the Record-Standby mode. Make sure you continue operations within 5 minutes after engaging Record-Standby mode (☞ pg. 26).
<p>18. The Picture Wipe function does not work.</p>	<p>18.</p> <ul style="list-style-type: none"> • The Slow Shutter mode is activated. • The Squeeze or Cinema mode is selected in the Recording Menu. 	<p>18.</p> <ul style="list-style-type: none"> • Make sure the Squeeze mode, Cinema mode, or Slow Shutter mode is not activated when preparing to use the Picture Wipe function (☞ pg. 26, 27).
<p>19. Even when Slow Shutter is not selected, the image looks like it is activated.</p>	<p>19.</p> <ul style="list-style-type: none"> • When shooting in the dark, the unit becomes highly sensitive to light and the image takes on an effect similar to Slow Shutter. 	<p>19.</p> <ul style="list-style-type: none"> • If you want the lighting to look more natural, set GAIN UP to "AGC" or "OFF" in the Recording Menu (☞ pg. 22).
<p>20. There is no strobe when the Classic Film or Strobe mode is activated.</p>	<p>20.</p> <ul style="list-style-type: none"> • The Picture Wipe or Dissolve function is in use. 	<p>20.</p> <ul style="list-style-type: none"> • Do not try to use the Classic Film or Strobe mode during a scene transition (☞ pg. 28).
<p>21. White Balance cannot be activated.</p>	<p>21.</p> <ul style="list-style-type: none"> • The Sepia or Monotone mode is activated. 	<p>21.</p> <ul style="list-style-type: none"> • Turn off Sepia or Monotone before setting White Balance (☞ pg. 28).
<p>22. When shooting a subject illuminated by bright light, vertical lines appear.</p>	<p>22.</p> <ul style="list-style-type: none"> • This is a result of exceedingly high contrast, and is not a malfunction. 	<p>22.</p> <p style="text-align: center;">_____</p>
<p>23. When the screen is under direct sunlight during shooting, the screen becomes red or black for an instant.</p>	<p>23.</p> <ul style="list-style-type: none"> • This is not a malfunction. 	<p>23.</p> <p style="text-align: center;">_____</p>

SYMPTOM	POSSIBLE CAUSES	CORRECTIVE ACTION
24. During recording, the date/time does not appear.	24. • "DISPLAY" is set to "OFF" in the Date/Time Menu.	24. • Set "DISPLAY" to "ON" in the Date/Time Menu (☞ pg. 9). • Press DISPLAY for longer than 1 second to make the indicators appear (☞ pg. 15).
25. The indicators and messages do not appear on screen.	25. • "ON SCREEN" is set to "OFF" in the Date/Time Menu.	25. • Set "ON SCREEN" to "ON" in the Date/Time Menu (☞ pg. 19). • Press DISPLAY for longer than 1 second to make the indicators appear (☞ pg. 15).
26. The indicators do not appear.	26. • You have made the indicators disappear.	26. • Press DISPLAY for longer than 1 second to make the indicators appear (☞ pg. 15).
27. The viewfinder and the lens have become dirty (ex. fingerprints).	27. _____	27. • Wipe them gently with soft cloth. Wiping strongly can cause damage.
28. The viewfinder indications blink.	28. • Certain Fade/Wipe effects, certain modes of Programme AE with special effects, Picture Stabilizer and other functions that cannot be used together are selected at the same time.	28. • Re-read the sections covering Fade/Wipe effects, Programme AE with special effects and Picture Stabilizer (☞ pg. 16, 25, 26, 28, 29).
29. Coloured bright spots appear all over the viewfinder.	29. • The viewfinder is made with high-precision technology. However, black spots or bright spots of light (red, green or blue) may appear constantly in the viewfinder. These spots are not recorded on the tape. This is not due to any defect of the unit. (Effective dots: more than 99.99 %)	29. _____
30. An unusual mark appears.	30. _____	30. • Check the section of the manual that explains viewfinder indications (☞ pg. 64, 65).

CONTINUED ON NEXT PAGE

SYMPTOM	POSSIBLE CAUSES	CORRECTIVE ACTION
31. An error indication (E01 — E06) appears.	31. • A malfunction of some kind has occurred. In this case the camcorder's functions become unusable.	31. • Remove the power supply (battery pack, etc.), clock battery and wait a few minutes for the indication to clear. When it does, you can resume using the camcorder. If the indication remains even though you repeat the above two or three times, please consult your nearest JVC dealer.
32. The charge indicator on the AC Power Adapter/Charger does not light.	32. • The temperature of the battery is extremely high/low. • Charging is difficult in places subject to extremely high/low temperatures.	32. • To protect the battery, it is recommended to charge it in places with a temperature of 10°C to 35°C (ⓘ pg. 67).
33. The recording mode indicator "LP" blinks.	33. • This occurs when recording in the LP mode is not available. After the indicator blinks, the recording mode switches to "SP" and recording goes on.	33. <hr/>
34. Picture does not appear in the viewfinder.	34. • The lens cover is closed.	34. • Open the lens cover (ⓘ pg. 14).
35. When the image is printed from the printer, a black bar appears at the bottom of the screen.	35. • This is not a malfunction.	35. • By recording with Picture Stabilizer activated (ⓘ pg. 16) this can be avoided.
36. The power lamp blinks.	36. • The camcorder was turned on when the battery power was almost gone.	36. • Replace with a charged battery pack (ⓘ pg. 6)
37. There are disturbances in audio.	37. • If Audio Dubbing has been performed repeatedly on the same portion of the tape, disturbance to the sound may result.	37. • Use a new, or infrequently used, tape for Audio Dubbing (ⓘ pg. 54, 55).

LENS COVER Open/Close Ring

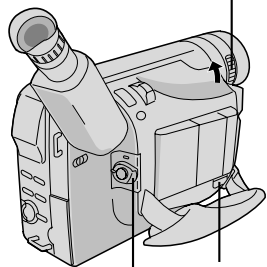

BATTERY RELEASE

Set to "POWER OFF".

PUSH HERE

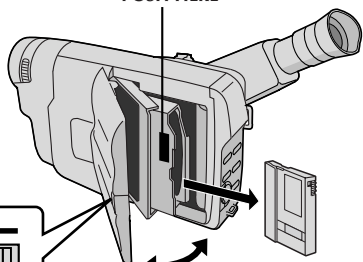

Remove.

OPEN/EJECT switch

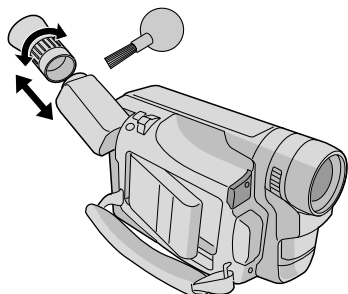

After Use

- 1** Set the Power Switch to "POWER OFF" to turn off the camcorder.
- 2** Press **OPEN/EJECT** in the direction of the arrow then swing the cover open until it locks. The cassette holder opens automatically. Remove the cassette.
- 3** Press "PUSH HERE" to close the cassette cover.
- 4** Slide **BATTERY RELEASE** to remove the battery pack.
- 5** Turn the **LENS COVER Open/Close Ring** to close the lens cover.

Cleaning The Camcorder







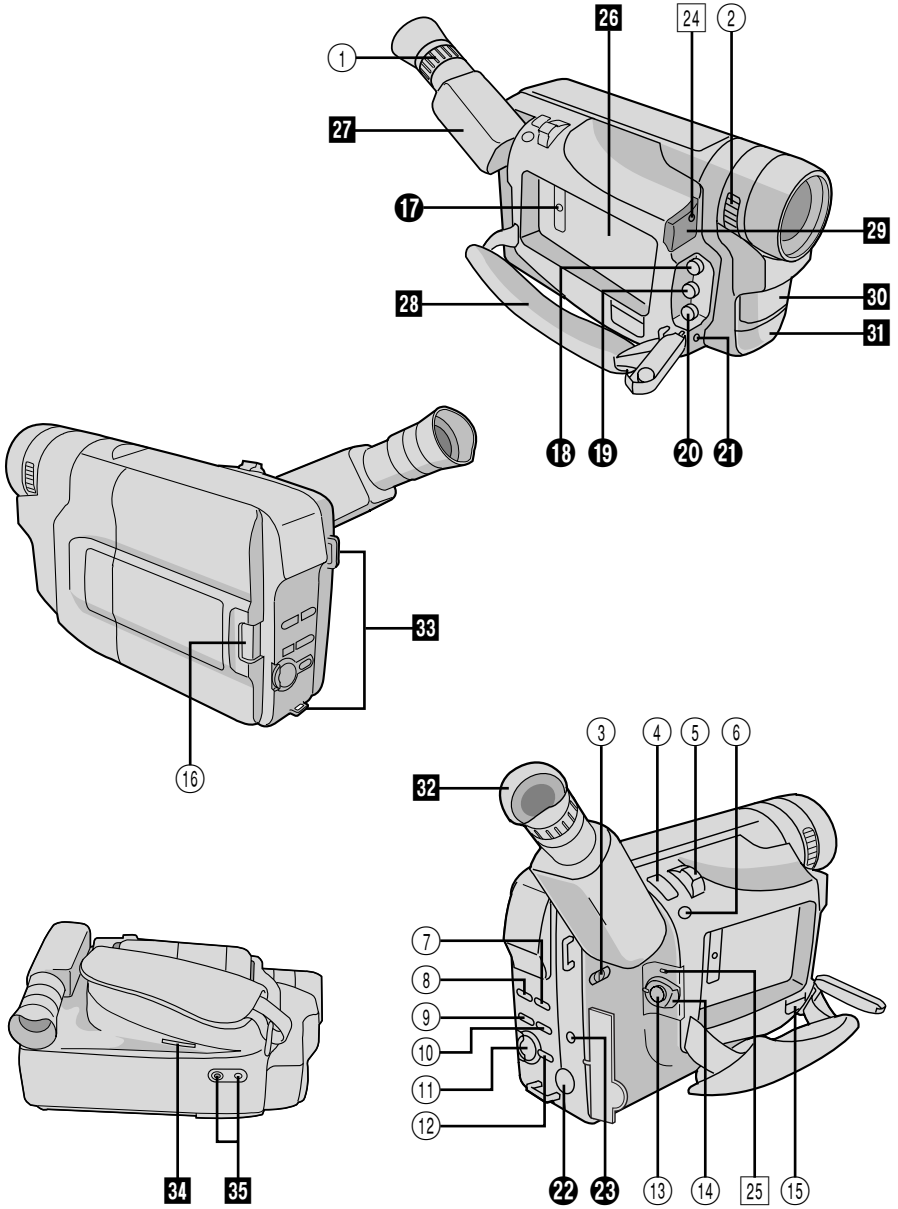







- 1 CLEAN EXTERIOR**
Wipe gently with a soft cloth.
• Put cloth in diluted mild soap and wring it well to wipe off heavy dirt. Then wipe again with a dry cloth.
- 2 CLEAN LENS**
Blow it with a blower brush, then wipe gently with lens cleaning paper.
- 3 REMOVE EYEPIECE**
Turn the eyepiece counterclockwise and pull it out.
- 4 CLEAN VIEWFINDER**
Remove dust using a blower brush.
- 5 RE-ATTACH EYEPIECE**
Re-attach the eyepiece and turn it clockwise.

NOTES:









- Avoid using strong cleaning agents such as benzine or alcohol.
- Cleaning should be done only after the battery pack has been removed or other power units have been disconnected.
- Mould may form if the lens is left dirty.
- When using a cleaner or chemically treated cloth refer to the cautions of each product.
- When removing the eyepiece, be sure to hold the viewfinder securely.





Controls

- ① Dioptre Adjustment Control  pg. 12
- ② Lens Cover Open/Close Ring  pg. 14
- ③ Video Light Switch
[LIGHT OFF/AUTO/ON]  pg. 17
- ④ Snapshot Button [SNAPSHOT]  pg. 20
- ⑤ Power Zoom Lever [T/W]  pg. 16
- ⑥ Picture Stabilizer Button
[P. STABILIZER]  pg. 16
- ⑦ Fast-Forward Button [▶▶, FF]  pg. 36
- ⑧ Rewind Button [◀◀, REW]  pg. 36
- ⑨ Stop Button [■, STOP]  pg. 36
- ⑩ Play/Pause Button
[▶/⏸, PLAY/PAUSE]  pg. 36
- ⑪ Select Dial [+ , - , PUSH]  pg. 9, 22
- ⑫ MENU/DISPLAY Button  pg. 15, 22
- ⑬ Recording Start/Stop Button  pg. 14
- ⑭ Power Switch  pg. 14, 36
- ⑮ Battery Release Switch
[BATTERY RELEASE]  pg. 6
- ⑯ OPEN/EJECT Switch  pg. 10











Connectors

- ⑰ DC IN Jack  pg. 7
- The connectors ⑱ to ⑳ are located beneath the cover.
- ⑱ Video Output Connector  pg. 40
 - ⑲ Audio Output Connector [L]  pg. 40
 - ⑳ Audio Output Connector [R]  pg. 40
 - ㉑ External Stereo Microphone Input Connector
[MIC]  pg. 54
 - ㉒ S-Video Output Connector [S OUT]  pg. 40
 - ㉓ J Terminal [JLIP (Joint Level Interface Protocol)
Connector]  pg. 49
- Connect the editing cable when performing Random Assemble Editing ( pg. 48 – 53).
 - It is used to connect the camcorder to a device such as a personal computer.
For further details consult your nearest JVC dealer.
 - JLIP-controlled editing from camcorder to VCR is not possible if the VCR is not equipped with a J terminal.

Indicators

- ㉔ Tally Lamp  pg. 14
- ㉕ Power Lamp  pg. 14

Other Parts

- ㉖ Battery Pack Mount  pg. 6
- ㉗ Viewfinder  pg. 12
- ㉘ Grip Strap  pg. 12
- ㉙ • Camera sensor
Be careful not to cover this area; a sensor necessary for shooting is built-in here.
• Remote Sensor  pg. 43
- ㉚ Video Light  pg. 17
- ㉛ Stereo Microphone  pg. 54
- ㉜ Eyepiece  pg. 61
- ㉝ Shoulder Strap Eyelets  pg. 13
- ㉞ Clock Battery Slot  pg. 8
- ㉟ Tripod Mounting Socket  pg. 13

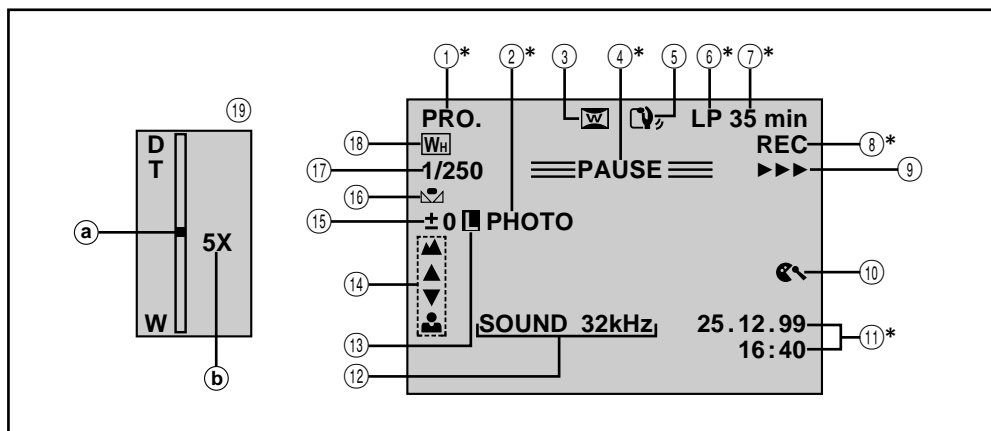

Viewfinder Indications During Recording

No.	Function	
①*	Displays the operation mode position.	(☞ pg. 14)
②*	Appears when taking a Snapshot.	(☞ pg. 20)
③	Appears when in the Squeeze or Cinema mode.	(☞ pg. 23)
④*	Appears when in the Record-Standby mode.	(☞ pg. 14)
⑤	Appears when Picture Stabilizer is engaged.	(☞ pg. 16)
⑥*	Displays the recording mode (SP or LP).	(☞ pg. 11)
⑦*	Displays the tape remaining time.	(☞ pg. 15)
⑧*	Appears during recording.	(☞ pg. 14)
⑨	Appears while the tape is running.	(☞ pg. 14)
⑩	Appears when the wind cut mode is engaged to cut down on noise created by wind.	(☞ pg. 24)
⑪*	Displays the date/time.	(☞ pg. 19)
⑫	Displays the sound mode for approx. 5 seconds after turning on the camcorder.	(☞ pg. 24)
⑬	Appears when the iris is locked.	(☞ pg. 33)
⑭	Appears when the focus is adjusted manually.	(☞ pg. 31)
⑮	Appears when the exposure is adjusted.	(☞ pg. 32)
⑯	Appears when the white balance is adjusted.	(☞ pg. 35)
⑰	Displays the selected Programme AE with special effects.	(☞ pg. 29)
⑱	Displays the selected Fade/Wipe effect.	(☞ pg. 27)
⑲	Appears during zooming. a Zoom level indicator b Approximate zoom ratio	(☞ pg. 16)

* :Pressing **DISPLAY** for longer than 1 second lets you remove indications marked with * from the screen.

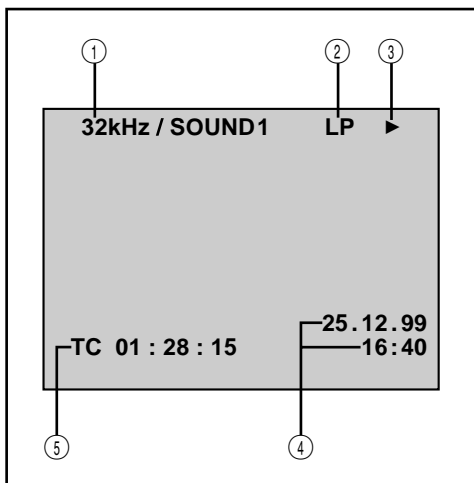





Viewfinder Indications During Playback

No.	Function
①	Displays the sound mode. (☞ pg. 39)
②	Displays the recording mode.
③	Appears while a tape is running. ▶ : Playback ▶▶ : Fast-Forward/Shuttle search ◀◀ : Rewind/Shuttle search : Pause ▶ : Forward slow-motion ◀ : Reverse slow-motion ● : Audio Dubbing
④	Displays the date/time. (☞ pg. 39)
⑤	Displays the time code. (☞ pg. 39)



Warning Indications

Indications	Function
	Displays the battery remaining power. Remaining power level: high → → → Remaining power level: exhausted As the battery power comes close to nil, the battery indicator blinks. When the battery power is exhausted, power turns off automatically.
	Appears when no tape is loaded, or when the erase protection tab is set to "SAVE". (☞ pg. 10)
	Appears if dirt is detected on the heads during recording. (☞ pg. 68)
	Appears if condensation occurs. When this indication is displayed, the camcorder turns off automatically.
	Appears for approx. 10 seconds after power is turned on. Also blinks when the clock (lithium) battery is either not installed or has discharged. Install or replace the old battery with a new one. (☞ pg. 8)
LENS COVER	Blinks for approx. 5 seconds when power is turned on with the lens cover closed. (☞ pg. 14)
TAPE!	Appears for 10 seconds after power is turned on if there is no tape loaded.
TAPE END	Appears when the tape ends during recording or playback. (☞ pg. 15)
SET DATE/TIME!	<ul style="list-style-type: none"> • Appears when the date/time is not set. (☞ pg. 9) • Appears when the clock (lithium) battery is discharged and the previously set date/time is erased. (☞ pg. 9)
E01 — E06	The error indications (E01 — E06) show what type of malfunction has occurred. When an error indication appears, the camcorder turns off automatically. Remove the power supply (battery, etc.), clock battery and wait a few minutes for the indication to clear. When it does, you can resume using the camcorder. If the indication remains, consult your nearest JVC dealer. (☞ pg. 60)
ERROR! REFER MANUAL	Appears when Audio Dubbing is unavailable. (☞ pg. 54)









A

- AC Power Adapter/Charger  pg. 6, 7
- Audio Dubbing  pg. 54
- Auto Focus  pg. 30
- Auto Shut off  pg. 15, 36







B

- Battery Low  pg. 65
- Battery Pack  pg. 6, 7, 67

C

- Car Battery  pg. 7
- Charge Marker  pg. 7
- Charge The Battery Pack  pg. 6
- Cinema  pg. 23
- Classic Film  pg. 29
- Clean The Camcorder  pg. 61
- Clock (Lithium) Battery  pg. 8
- Connections  pg. 7, 40, 49

D

- Date/Time Display  pg. 19, 39
- Date/Time Settings  pg. 9
- Demonstration Mode  pg. 24
- Digital Zoom  pg. 23
- Discharge The Battery Pack  pg. 6
- Dioptr Adjustment  pg. 12
- Dubbing  pg. 42

E

- Exposure Control  pg. 32

F

- Fade-In/Out  pg. 25
- Fast-Forward The Tape  pg. 36

G

- Gain Up  pg. 23
- Grip Adjustment  pg. 12

I

- Iris  pg. 33
- Iris Lock  pg. 33









L

- Load A Tape  pg. 10









M

- Manual Focus  pg. 31
- Monotone  pg. 29
- Motor Drive Mode  pg. 21















P

- Picture Stabilizer  pg. 16
- Picture Wipe/Dissolve  pg. 26
- Playback Menu  pg. 38
- Playback Special Effects  pg. 47
- Playback Zoom  pg. 46
- Power Switch Position  pg. 14
- Programme AE With Special Effects  pg. 28
- Provided Accessories  pg. 3

R

- Random Assemble Editing  pg. 48 – 53
- Record Safety Tab  pg. 10
- Record-Standby  pg. 14
- Recording Format  pg. 4
- Recording Mode  pg. 11
- Recording Menu  pg. 22, 23
- Remote Control  pg. 43
- Rewind The Tape  pg. 36

S

- Sepia  pg. 29
- Set Remote Control/VCR Code  pg. 48
- Shoulder Strap Attachment  pg. 13
- Shuttle Search  pg. 37
- Shutter Speed  pg. 29
- Slow-Motion Playback  pg. 45
- Slow Shutter  pg. 29
- Snapshot Mode  pg. 20, 21
- Sound Mode  pg. 24
- Specifications  pg. 69
- Squeeze  pg. 23
- Still Playback  pg. 37
- Strobe  pg. 29
- System Menu  pg. 24

T

- Tally  pg. 24
- Tele Macro  pg. 23
- Time Code  pg. 4, 18
- Tripod Mounting  pg. 13
- Twilight  pg. 29

U

- Unload A Tape  pg. 10

V

- Video Light  pg. 17
- Viewfinder Indications  pg. 64, 65

W

- White Balance  pg. 34, 35
- Wide Mode  pg. 23
- Wind Cut  pg. 24
- Wipe In/Out  pg. 25, 26

Z

- Zooming  pg. 16

DANGER:

Video Light

- The video light becomes extremely hot. Do not touch it either while in operation or soon after turning it off, otherwise serious injury may result.
- Do not place the camcorder into the carrying case immediately after using the video light, since it remains extremely hot for some time.
- When operating, keep a distance of about 30 cm between the video light and people or object.
- Do not use near flammable or explosive materials.
- It is recommended that you consult your nearest JVC dealer for replacing the video light.

Battery Packs

The battery packs are nickel-cadmium or nickel metal-hydrate batteries. Before using the supplied battery pack or an optional battery pack, be sure to read the following cautions:

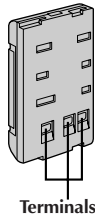

1. To avoid hazard . . .

- ... do not burn.
- ... do not short-circuit the terminals.
- ... do not modify or disassemble.
- ... use only specified chargers.

2. To prevent damage and prolong service life . . .

- ... do not subject to unnecessary shock.
- ... avoid repeated charging without fully discharging.
- ... charge in an environment where temperatures are within the tolerances shown in the chart below. This is a chemical reaction type battery—cooler temperatures impede chemical reaction, while warmer temperatures can prevent complete charging.
- ... store in a cool, dry place. Extended exposure to high temperatures will increase natural discharge and shorten service life.
- ... avoid prolonged uncharged storage.
- ... remove from charger or powered unit when not in use, as some machines use current even when switched off.

NOTES:

- It is normal for the battery pack to be warm after charging, or after use.
Temperature Range Specifications
 Charging 10°C to 35°C (50°F to 95°F)
 Operation 0°C to 40°C (32°F to 104°F)
 Storage -10°C to 30°C (14°F to 86°F)
- Recharging time is based on room temperature of 20°C (68°F).
- The lower the temperature, the longer recharging takes.

Cassettes

To properly use and store your cassettes, be sure to read the following cautions:

1. During use . . .

- ... make sure the cassette bears the Mini DV mark.
- ... be aware that recording onto prerecorded tapes automatically erases the previously recorded video and audio signals.
- ... make sure the cassette is positioned properly when inserting.
- ... do not load and unload the cassette repeatedly without allowing the tape to run at all. This slackens the tape and can result in damage.
- ... do not open the front tape cover. This exposes the tape to fingerprints and dust.

2. Store cassettes . . .

- ... away from heaters or other heat sources.
- ... out of direct sunlight.
- ... where they won't be subject to unnecessary shock or vibration.
- ... where they won't be exposed to strong magnetic fields (such as those generated by motors, transformers or magnets).
- ... vertically, in their original cases.

Main Unit

1. For safety, DO NOT . . .

- ... open the camcorder's chassis.
- ... disassemble or modify the unit.
- ... short-circuit the terminals of the battery pack. Keep it away from metallic objects when not in use.
- ... allow inflammables, water or metallic objects to enter the unit.
- ... remove the battery pack or disconnect the power supply while the power is on.
- ... leave the battery pack attached when the camcorder is not in use.

2. Avoid using the unit . . .

- ... in places subject to excessive humidity or dust.
- ... in places subject to soot or steam such as near a cooking stove.
- ... in places subject to excessive shock or vibration.
- ... near a television set.
- ... near appliances generating strong magnetic or electric fields (speakers, broadcasting antennas, etc.).
- ... in places subject to extremely high (over 40°C or 104°F) or extremely low (under 0°C or 32°F) temperatures.

3. DO NOT leave the unit . . .

- ... in places of over 50°C (122°F).
- ... in places where humidity is extremely low. (below 35%) or extremely high (above 80%).
- ... in direct sunlight.
- ... in a closed car in summer.
- ... near a heater.

4. To protect the unit, DO NOT . . .

- ... allow it to become wet.
- ... drop the unit or strike it against hard objects.
- ... subject it to shock or excessive vibration during transportation.
- ... keep the lens directed at extremely bright objects for long periods.
- ... direct the eyepiece of the viewfinder at the sun.
- ... carry it by holding the viewfinder. Be sure to hold the main unit with both hands or use the grip.
- ... swing it excessively when using the shoulder strap.

5. Dirty heads can cause the following problems:

- No picture and sound during playback (blue back screen).
- Blocks of noise appear during playback.
- During recording, the Head Clog Warning indicator “⊗” appears.

In such cases, use the optional Cleaning Cassette. Insert it and play back. If the cassette is used more than once consecutively, damage to the video heads may result. After the camcorder plays back for about 20 seconds, it stops automatically. Also refer to the Cleaning Cassette's instructions. If, after using the Cleaning Cassette, the problems still exist, consult your nearest JVC dealer. Mechanical moving parts used to move the video heads and video tape tend to become dirty and worn out over time. In order to maintain a clear picture at all times, periodic check-ups are recommended after using the unit for about 1,000 hours. For periodic check-ups please consult your nearest JVC dealer.

About moisture condensation . . .

- You may have observed that pouring a cold liquid into a glass will cause drops of water to form on the glass' outer surface. This same phenomenon occurs on the head drum of a camcorder when it is moved from a cool place to a warm place, after heating a cold room, under extremely humid conditions or in a place directly subjected to the cool air from an air conditioner.
- Moisture on the head drum can cause severe damage to the video tape, and can lead to internal damage to the camcorder itself.

Serious malfunctioning

If malfunctioning occurs, stop using the unit immediately and consult your local JVC dealer.

Camcorder



General

Power supply	: DC 6.0 V 
Power consumption	
Light on	: Approx. 8.0 W
Light off	: Approx. 5.0 W
Format	: DV Format (SD mode)
Signal format	: PAL Standard
Video signal recording format	: Digital Component Recording
Cassette	: Mini DV Cassette
Tape Speed	: SP: 18.8 mm/s LP: 12.5 mm/s
Maximum recording time	: SP: 60 min. LP: 90 min. (using M-DV60ME cassette)
Pickup	: 1/4" CCD
Lens	: F1.6, f = 3.9 to 62.4 mm, 16:1 Power Zoom Lens
Filter diameter	: \varnothing 40.5 mm
Viewfinder	: Electronic viewfinder with 0.55" colour LCD
Operating temperature	: 0°C to 40°C
Operating humidity	: 35% to 80%
Storage temperature	: -20°C to 50°C
Dimensions	: 89 (W) x 119 (H) x 198 (D) mm (with the viewfinder fully tilted downward)
Weight	: Approx. 640 g

Connectors

S-Video	: Y: 1 Vp-p, 75 Ω , analogue output C: 0.29 Vp-p, 75 Ω , analogue output
JLIP	: \varnothing 3.5 mm, 4-pole, mini-head jack (compatible with RC-5325 plug)
Video	: 1 Vp-p, 75 Ω unbalanced, analogue output (via Video output connector)
Audio	: -8 dBs, 1 k Ω analogue output (via Audio output connector)
External microphone input	: -68 dBs, high impedance unbalanced with \varnothing 3.5 mm (stereo)

AC Power Adapter/Charger AA-V15EG

Power requirement	: AC 110 V to 240 V, 50/60 Hz
Power consumption	: 23 W
Output	
Charge	: DC 8.5 V  , 1.3 A
VTR	: DC 6.3 V  , 1.8 A
Charging system	: Constant current, peak detection, timer controlled
Dimensions	: 140 (W) x 42 (H) x 68 (D) mm
Weight	: Approx. 300 g

Specifications shown are for SP mode unless otherwise indicated. E & O.E. Design and specifications subject to change without notice.

EN

GR-DVF1

JVC

VICTOR COMPANY OF JAPAN, LIMITED